

MODEL 4902



T-MAXX 2.5R

OWNERS MANUAL

TRAXXAS

INTRODUCTION

3 BEFORE YOU PROCEED

4 SAFETY PRECAUTIONS

5 TOOLS, SUPPLIES AND
REQUIRED EQUIPMENT

6 ANATOMY OF YOUR
T-MAXX 2.5R

7 QUICK START:
GETTING UP TO SPEED

8 GLUING THE TIRES
AND DECORATING
YOUR T-MAXX 2.5R

9 THE TRAXXAS
TQ-3 RADIO SYSTEM

18 THE TRX 2.5R
RACING ENGINE

34 DRIVING YOUR
T-MAXX 2.5R

35 TUNING ADJUSTMENTS

40 MAINTAINING AND
STORING YOUR
T-MAXX 2.5R

42 TROUBLESHOOTING

44 INDEX

Thank you for purchasing a Traxxas T-Maxx 2.5R Nitro Monster Truck. T-Maxx is legendary for providing the perfect balance of size, speed, power and agility. With the new T-Maxx 2.5R, we've added the extremely powerful, efficient, lightweight, TRX 2.5R Racing Engine. T-Maxx 2.5R has been carefully engineered to keep its weight low and maintain an incredible power-to-weight ratio and seemingly perfect performance balance.

Your T-Maxx 2.5R combines automatic, two-speed shifting in forward and reverse, with powerful four-wheel disc braking. The patent pending transmission design and three-channel TQ-3 radio system put these functions right at your fingertips.

T-Maxx 2.5R is equipped with the patent pending Optidrive™ electronic transmission control. Advanced electronic reduce the number of moving parts inside the transmission for less weight, smooth engagement and efficient performance.

The power and reliability of the TRX 2.5R Racing Engine has been proven in thousands of Traxxas models. The rear exhaust design, trick porting, and sophisticated carburetor all come together for dramatic, high-revving power output. Add to that the smooth convenience of the on-board EZ-Start electric starting system and the TRX 2.5R Racing Engine remains in a class all by itself.

Traxxas was the first with standard on-board electric starting. The EZ-Start has evolved into an incredibly advanced and reliable starting solution, featuring thermal protection for the motor and built-in diagnostics to monitor the condition of the glow plug.

We know you're excited about getting your new T-Maxx 2.5R on the road, but it's very important that you take some time to read through the Owners Manual. This manual contains all the necessary set-up, break-in, tuning, and operating procedures that allow you to unlock the incredible performance and adjustment potential that Traxxas engineers designed into T-Maxx 2.5R. **Even if you are an experienced R/C enthusiast, it's important to read and follow the procedures in this manual. T-Maxx 2.5R contains new technologies in the engine, suspension, and transmission operation that you**

Traxxas Support

Traxxas support is with you every step of the way. Refer to the next page to find out how to contact us and what your support options are.



Quick Start

This manual is designed with a Quick Start path  that covers only the necessary procedures to get your model up and running in the shortest time possible. If you are experienced with Traxxas products you will find it helpful and fast. Be sure and read through the rest of the manual to learn about important safety, maintenance, and adjustment procedures. Turn to page 7 to begin the Quick Start path.

may not be familiar with. Pay particular attention to the fuel and break-in requirements for the engine. The advanced design of the TRX 2.5R Racing Engine has a special break-in procedure that has been developed and proven to produce the best-performing engine possible. Using traditional or old-fashioned procedures could reduce engine performance and longevity.

T-Maxx 2.5R is made to be a complete package that starts with the highest level of engineering; a professionally produced DVD to acquaint you with the starting, racing, and maintenance procedures; and is equipped stock with the most powerful Ready-To-Race® engine available. We want you to feel confident that you own the best-performing truck in the market and that it is backed by a team of professionals who aim to provide the highest level of factory support possible. T-Maxx 2.5R is about experiencing total performance and satisfaction, not just with your truck, but also with the company that stands behind it.

Thank you again for going with Traxxas. We work hard every day to assure you the highest level of customer satisfaction possible. We truly want you to enjoy your new T-Maxx 2.5R!

BEFORE YOU PROCEED

Carefully read and follow all instructions in this and any accompanying materials to prevent serious damage to your T-Maxx 2.5R. Failure to follow these instructions will be considered abuse and/or neglect.

Before running your T-Maxx 2.5R, look over this entire manual and examine the truck carefully. If for some reason you decide the T-Maxx 2.5R is not what you wanted, then do not continue any further. Your hobby dealer absolutely cannot accept a T-Maxx 2.5R for return or exchange after it has been run.

WARNINGS, HELPFUL HINTS, & CROSS-REFERENCES

Throughout this manual, you'll notice warnings and helpful hints identified by the icons below. Be sure to read them!



An important warning about personal safety or avoiding damage to your T-Maxx 2.5R and related components.



Special advice from Traxxas to make things easier and more fun.



Refers you to a page with a related topic.

SUPPORT

If you have any questions about your T-Maxx 2.5R or its operation, call the Traxxas Technical Support line toll-free at: **1-888-TRAXXAS (1-888-872-9927)***

Technical support is available Monday through Friday from 8:30 am to 9:00 pm central time. Technical assistance is also available at www.Traxxas.com. You may also e-mail customer support with your question at support@Traxxas.com. Join hundreds of Traxxas R/C enthusiasts in our online community at www.Traxxas.com.

Traxxas offers a full-service, on-site repair facility to handle any of your Traxxas service needs. Maintenance, replacement parts, and accessories may be purchased directly from Traxxas by phone or online at www.BuyTraxxas.com. You can save time, along with shipping and handling costs, by purchasing replacement parts from your local dealer.

Do not hesitate to contact us with any of your product support needs. We want you to be thoroughly satisfied with your new T-Maxx 2.5R!

Traxxas
1100 Klein Road
Plano, Texas 75074
Phone: 972-265-8000
Toll-free 1-888-TRAXXAS

Traxxas U.K.
P.O. Box 1128
Winterbourne, Bristol BS36-2SH
England
Phone: 44-117-956-1002

Internet
www.Traxxas.com
E-mail: support@Traxxas.com

Entire contents ©2006 Traxxas. Traxxas, Maxx, T-Maxx 2.5R, TRX 2.5R Racing Engine, TQ-3, Top Fuel, EZ-Start, Ready-To-Race, Ready-To-Win, and ProGraphix are trademarks or registered trademarks of Traxxas. Other brand names and marks are the property of their respective holders and are used only for purposes of identification. No part of this manual may be reproduced or distributed in print or electronic media without the express written permission of Traxxas.

*Toll-free support is available to U.S. residents only. Outside the U.S., call 972-265-8000.

SAFETY PRECAUTIONS



All instructions and precautions outlined in this manual should be strictly followed to ensure safe operation of your T-Maxx 2.5R.



T-Maxx 2.5R is not intended for use by children under 16 years of age without the supervision of a responsible and knowledgeable adult.

All of us at Traxxas want you to safely enjoy your new T-Maxx 2.5R. Operate your T-Maxx 2.5R sensibly and with care, and it will be exciting, safe, and fun for you and those around you. Failure to operate your T-Maxx 2.5R in a safe and responsible manner may result in property damage and serious injury. The precautions outlined in this manual should be strictly followed to help ensure safe operation. You alone must see that the instructions are followed and the precautions are adhered to.







IMPORTANT POINTS TO REMEMBER

- ⦿ T-Maxx 2.5R is very fast! The T-Maxx 2.5R is intended for experienced users with a high level of skill. The TRX 2.5R Racing Engine is extremely powerful and may require skilled driving to maintain control. Children under 16 years of age and inexperienced drivers should not operate the T-Maxx 2.5R without the supervision of a responsible and knowledgeable (experienced) adult.
- ⦿ **Model engine fuel is dangerous and highly poisonous.** Always follow all directions and precautions printed on the fuel container. Model engine fuel is poisonous to humans and animals. Drinking the fuel can cause blindness and death. Handle with care and respect.
- ⦿ Model engine fuel, especially when in a fuel dispensing bottle, may look like a cool drink to a child. **Keep all fuel out of the reach of children at all times. Do not place fuel containers on the ground where children can reach them while you are driving.**
- ⦿ Model engine fuel is flammable. Never allow smoking, sparks, heat or flame in the presence of fuel or fuel vapors.
- ⦿ The engine, brakes, and exhaust system may become extremely hot during use. Be careful not to touch the parts, especially when refueling or stopping the engine.
- ⦿ Prolonged exposure to the engine exhaust can be harmful. Avoid breathing the engine exhaust. Always run your T-Maxx 2.5R outdoors, in a well-ventilated area. Never run the engine indoors.
- ⦿ Do not operate your T-Maxx 2.5R at night, or anytime your line of sight to the model may be obstructed or impaired in any way.
- ⦿ Never operate your T-Maxx 2.5R in crowds of people or busy pedestrian areas. T-Maxx 2.5R is very fast and could cause injury to those unaware of its presence. Keep small children at a safe distance away from the operating area.
- ⦿ Because T-Maxx 2.5R is controlled by radio, it is subject to radio interference from many sources beyond your control. Since radio interference can cause momentary loss of control, always allow a safety margin in all directions around your model to prevent collisions.
- ⦿ The engine can be loud. If the noise makes you uncomfortable, wear ear protection. Be considerate of your neighbors by not running your model early in the morning or late in the evening.
- ⦿ **Most importantly, use good common sense at all times.**

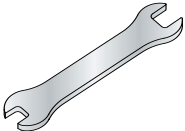
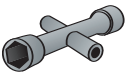

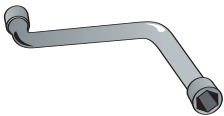
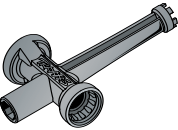





TOOLS, SUPPLIES, AND REQUIRED EQUIPMENT

T-Maxx 2.5R comes with a set of specialty metric tools. You'll need to purchase other items, available from your hobby dealer, to operate and maintain your model.

SUPPLIED TOOLS AND EQUIPMENT

				
U-joint wrench	8mm/5mm wrench	4-way wrench	Antenna nut wrench	Glow plug and wheel nut wrench
				
Suspension multi-tool	1.5mm "L" wrench	2.0mm "T" wrench	2.5mm "L" wrench	Foam air filter oil and extra air filter element (see page 23)

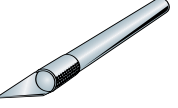
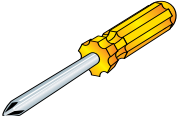
REQUIRED TOOLS AND EQUIPMENT (SOLD SEPARATELY)

	10% quart - #5010 20% quart - #5020 33% quart - #5030 10% gallon - #5060 20% gallon - #5070 33% gallon - #5080			
Traxxas Top Fuel™ see page 22	12 AA alkaline batteries	NiCad or NiMH 7.2V battery pack	NiCad or NiMH battery charger Traxxas part #3030X shown*	
				
Fuel dispensing bottle Traxxas part #5001 shown*	After-run oil to protect the engine from corrosion	Hobby knife	Philips screwdriver	Small flat-blade screwdriver for tuning (1/8 inch blade)

ACCESSORY EQUIPMENT (SOLD SEPARATELY)

			
TRX Power Charger Traxxas part #3030X	RX battery power pack Traxxas part #3037	RX Wiring Harness Traxxas part #3034	DC car adapter for TRX Power Charger Traxxas part #3032

*sold separately

➔ For more information on radio system batteries, see *Use the Right Batteries* on page 11.

➔ A peak-detecting charger is recommended for best performance and longest battery life. For more information, see *Use the Right Charger* on page 26.

i **Recommended Equipment**
These items are not required for the operation of your model, but are a good idea to include in any R/C toolbox:

- Safety glasses
- Thin, hobby-quality cyanoacrylate instant tire glue (CA glue)
- Side cutters or needle nose pliers

ANATOMY OF YOUR T-MAXX 2.5R

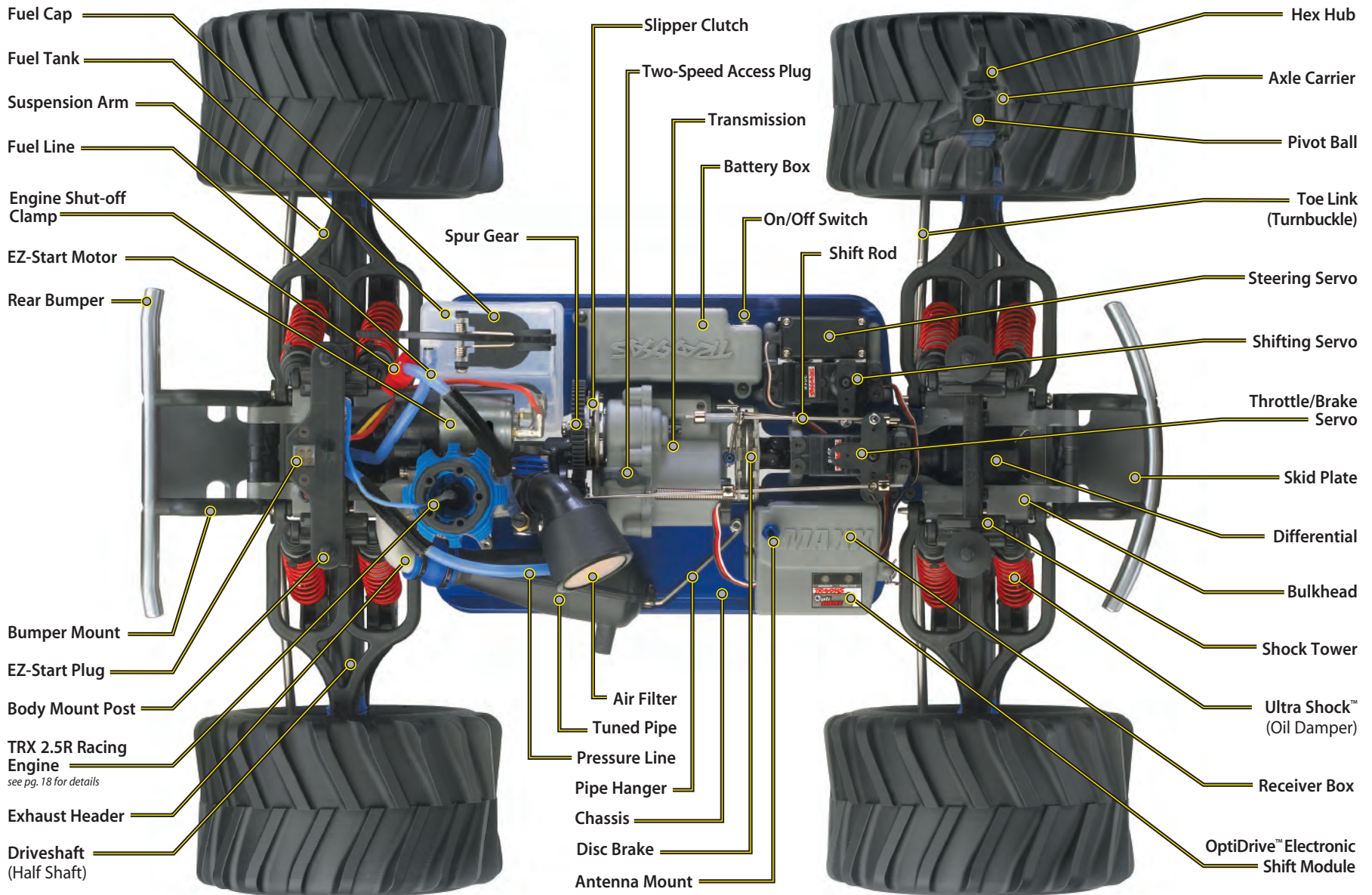

QUICK START: GETTING UP TO SPEED

The following guide is an overview of the procedures for getting your T-Maxx 2.5R running, from opening the box to breaking in and tuning your engine. Refer to the pages indicated for details on each step. Look for the Quick Start logo on the bottom corners of Quick Start pages.

- | | |
|---|--|
| <input type="checkbox"/> 1. Read the safety precautions on page 4
For your own safety, understand where carelessness and misuse could lead to personal injury. | <input type="checkbox"/> 10. Range test the radio system • See page 17
Follow this procedure to make sure your radio system works properly at a distance and that there is no interference from outside sources. |
| <input type="checkbox"/> 2. Charge the EZ-Start battery pack • See page 26
The EZ-Start requires a fully charged 7.2-volt battery pack (sold separately). | <input type="checkbox"/> 11. Fill the fuel tank • See page 23
Use your fuel-dispensing bottle* to fill the tank. |
| <input type="checkbox"/> 3. Install the antenna • See page 13.
Install the antenna mast on the T-Maxx 2.5R. | <input type="checkbox"/> 12. Connect the EZ-Start to the model • See page 27
Learn the proper way to use the EZ-Start electric starting system |
| <input type="checkbox"/> 4. Install batteries in the transmitter • See page 11
T-Maxx 2.5R requires 8 AA alkaline or rechargeable batteries* for the transmitter. | <input type="checkbox"/> 13. Start the engine • See page 28
Learn to use the correct starting procedure for your TRX 2.5R. |
| <input type="checkbox"/> 5. Decal and Install the body • See page 8
You will need to use the body during break in, so it's best to apply any additional decals before you use the body. | <input type="checkbox"/> 14. Break-in your engine • See page 28
Follow the break-in instructions exactly to ensure the best-performing, longest-lasting engine. |
| <input type="checkbox"/> 6. Install batteries in the model • See page 12
T-Maxx 2.5R requires 4 AA alkaline or rechargeable batteries* for the receiver. | <input type="checkbox"/> 15. Tune your engine • See page 31
Learn how to set the fuel mixture needles for optimum engine performance. |
| <input type="checkbox"/> 7. Install the EZ-Start battery • See page 26
Install and connect a charged 7.2-volt battery pack in the EZ-Start controller. | <input type="checkbox"/> 16. Drive your T-Maxx 2.5R • See page 34
Learn to use the two-speed and reverse functions on your truck, along with important driving precautions. |
| <input type="checkbox"/> 8. Turn on the radio system • See page 16
Make a habit of turning the transmitter on first, and off last. | <input type="checkbox"/> 17. Maintaining your Truck • See pages 40-41
Follow these critical steps to maintain the performance of your T-Maxx 2.5R and keep it in excellent running condition. |
| <input type="checkbox"/> 9. Check servo operation • See page 17
Make sure the throttle, shifting, and steering servos are working correctly. | |



The Quick Start Guide is not intended to replace the full operating instructions available in this manual. Please read this entire manual for complete instructions on the proper use and maintenance of your T-Maxx 2.5R.



Look for the Quick Start logo at the bottom of Quick Start pages.

*sold separately



Always wear safety glasses to prevent glue from splattering into your eyes.



The acetone in fingernail polish remover will remove excess glue from your fingers.



For best results while gluing, clean the bead of the tires and the grooves of the wheels with denatured alcohol before applying glue. This removes any mold release agent residue from the tires and wheels, providing a better bond.

TIRE GLUING

The factory tires on your T-Maxx 2.5R are already glued to the rims. The tires must be glued to the rims to prevent the rims from spinning inside the tires. The instructions here are provided to show you how to glue replacement tires to the rims in the future. Use CA tire glue available from your local hobby dealer. You can glue the tires without removing the wheels from the truck. For clarity, these instructions show the process with the wheels removed.

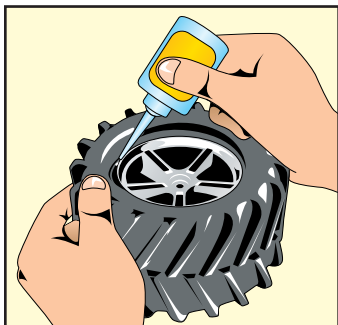
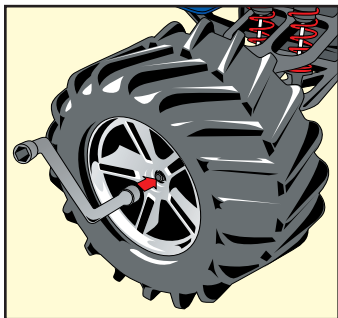

1. Remove a wheel from T-Maxx 2.5R using the larger (8mm) end of the glow plug (universal) wrench.
2. Use your thumb to push the side of the tire away from the rim. Place one or two drops of CA glue into the opening and release the tire. Capillary action will draw the glue around the bead of the tire.
3. Repeat step two at four or five points around the rim, until the tire is completely secured to the rim. Turn the rim over and repeat the process for the inside of the rim/tire. Repeat for the other three wheels.
4. Reinstall the wheels, make sure none of the axle pins have fallen out from behind the hex hubs.

APPLYING THE DECALS

The main decals have already been applied to your T-Maxx 2.5R. The extra decals provided are die-cut for easy removal. Use a hobby knife to lift the corner of a decal and remove it from the backing.

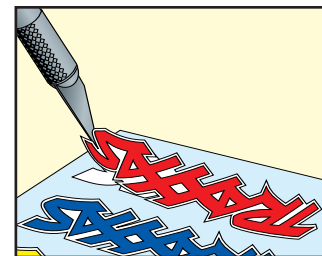

Carefully position the decal over the desired location and press one side on the body. Pull the decal tight and use a finger to gradually smooth out any air bubbles as you apply the decal.

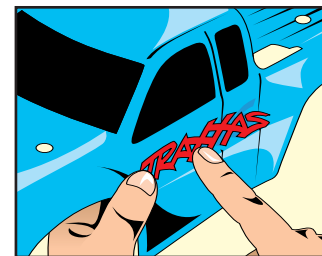

Look at the photos on the box for typical decal placement.

THE TRAXXAS TQ-3 RADIO SYSTEM

Your T-Maxx 2.5R is equipped with the TQ-3 radio system. The TQ-3 is a 3-channel system that provides up to a quarter mile range and control for up to three servo outputs. The TQ-3 works in conjunction with the OptiDrive™ Electronic Shift Module to monitor and control the input and output signals for the throttle and shifting servos (channels). The OptiDrive monitors the voltage of the on-board batteries. The "Function" LED will flash red if the battery voltage is too low.

TQ-3 TRANSMITTER

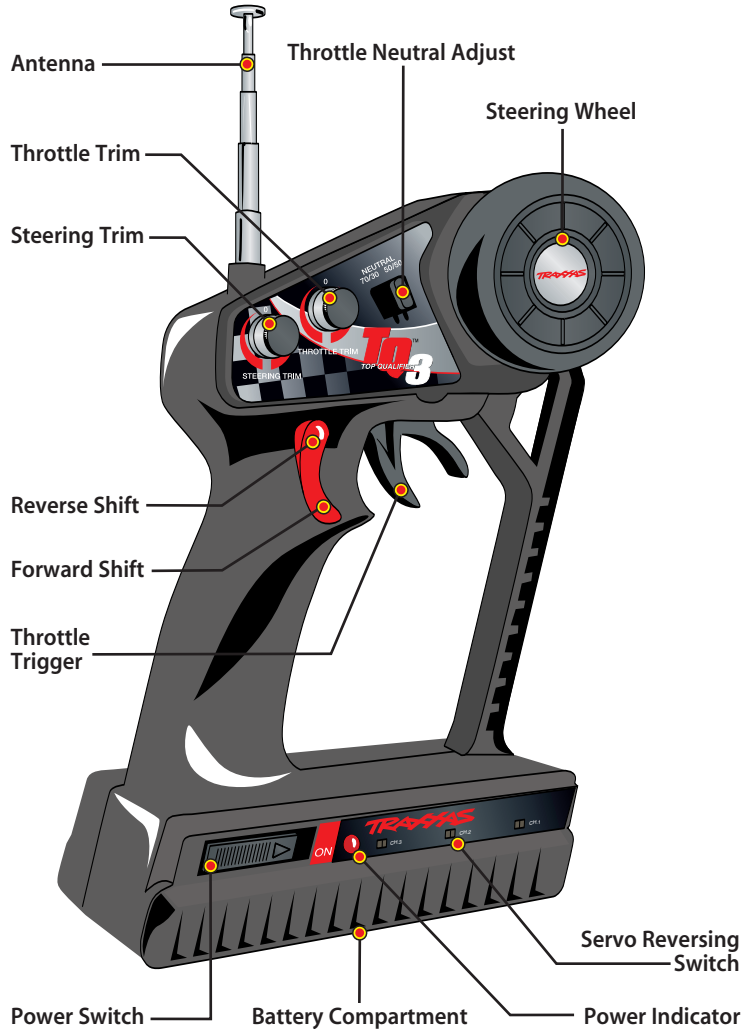

T-MAXX 2.5R WIRING DIAGRAM

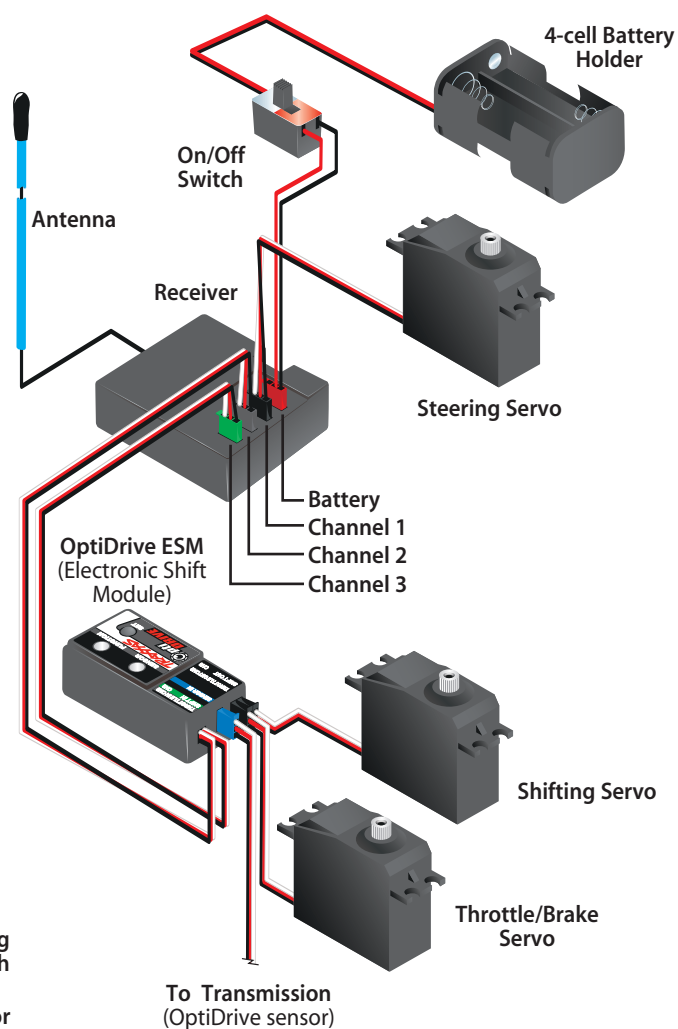

i The OptiDrive ESM is designed to adapt and work with aftermarket three channel radio systems (see page 15).









Learn terms related to the TRX 2.5R Racing Engine beginning on page 20.

RADIO SYSTEM TERMINOLOGY

Please take a moment to familiarize yourself with these radio-system terms. They will be used throughout this manual.

5-Cell Pack – Another term for RX Pack or rechargeable receiver pack. The RX pack is made up of five rechargeable NiMH battery cells and is used in place of the 4AA batteries in the model.

Channel - The 27 MHz frequency band is divided into 6 channels so that up to six models can be operated simultaneously. Each channel is referred to by its flag color and channel number, as shown below.

CHANNEL	FREQUENCY BAND	FLAG COLOR	TRAXXAS PART NO.
 1	26.995	BROWN	2031
 2	27.045	RED	2032
 3	27.095	ORANGE	2033
 4	27.145	YELLOW	2034
 5	27.195	GREEN	2035
 6	27.255	BLUE	2036

Clearing your frequency - A routine, verbal check to make sure nobody else in your area is operating on the same channel. Always clear your frequency by calling out your channel number before operating your model. Wait or move to another area if your channel is already being used.

Crystal (X-tal) - The plug-in device that determines which channel the radio system will operate on. For each channel, there are two crystals, one for the receiver and one for the transmitter. Of those two crystals, the one marked "RX" with the lower number (.455 MHz lower) must be inserted into the receiver.

Frequency band - The radio frequency used by the transmitter to send signals to your T-Maxx 2.5R. All Traxxas RTR models operate on a 27 MHz frequency band.

mAh – Abbreviation for milliamp hour. Measure of the capacity of the battery pack. The higher the number, the longer the battery will last between recharges.

Neutral position - The standing position that the servos seek when the transmitter controls are at the neutral setting.

NiCad - Abbreviation for nickel-cadmium. The original rechargeable hobby pack, NiCad batteries have very high current handling, high capacity, and can last up to 1000 charging cycles. Good charging procedures are required to reduce the possibility of developing a "memory" effect and shortened run times.

NiMH - Abbreviation for nickel-metal hydride. Rechargeable NiMH batteries offer high current handling, and much greater resistance to the "memory" effect. NiMH batteries generally allow higher capacity than NiCad batteries. They can last up to 500 charge cycles. A peak charger designed for NiMH batteries is required for optimal performance.

Receiver - The radio unit inside your T-Maxx 2.5R that receives signals from the transmitter and relays them to the servos.

RX Pack - RX is a common abbreviation for the radio receiver and items associated with it. RX Pack denotes the optional rechargeable battery pack used to power the radio system in the model. It is available as Traxxas part number 3037.

Servos - Small motor units in your T-Maxx 2.5R that operate the throttle and steering mechanisms.

Three-channel radio system - The TQ-3 radio system, consisting of the receiver, the transmitter, and the servos. The system uses three channels: one to operate the throttle, one to shift the transmission, and one to operate the steering.

Transmitter - The hand-held radio unit that sends throttle and steering instructions to your T-Maxx 2.5R.

Trim - The fine-tuning adjustment of the neutral position of the servos, made by turning the throttle and steering trim knobs on the face of the transmitter.

INSTALLING TRANSMITTER BATTERIES

Your TQ-3 transmitter uses 8 AA batteries. The battery compartment is located in the base of the transmitter.

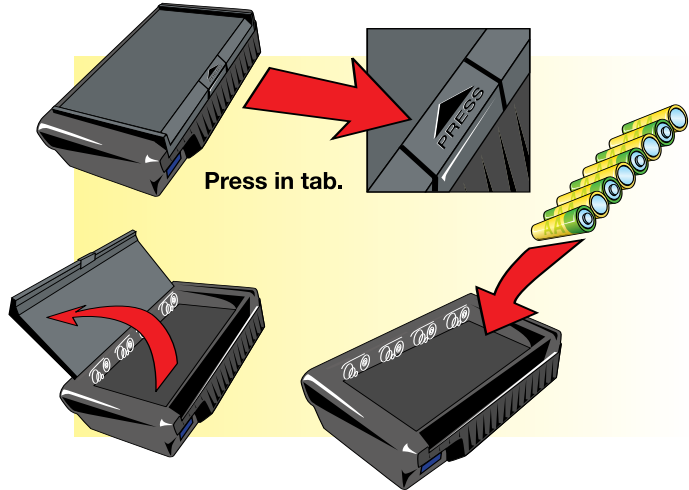

1. Remove the battery compartment door by pressing the tab and lifting the door up.
2. Install the batteries in the correct orientation as indicated in the battery compartment.
3. Reinstall the battery door and snap it closed.

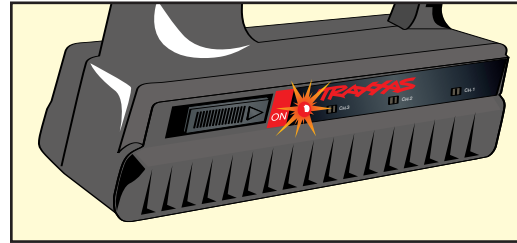

4. Turn on the transmitter and check the power indicator for a solid red light.

If the power indicator light flashes, then the transmitter batteries are weak, discharged or possibly installed incorrectly. Replace with new or freshly charged batteries. The power indicator light does not indicate the charge level of the batteries installed in the model.

i Use the Right Batteries
Your transmitter uses AA batteries. Use new alkaline batteries, or rechargeable batteries such as NiCad or NiMH (Nickel Metal Hydride) batteries in your transmitter. Make sure rechargeable batteries are fully charged according to the manufacturer's instructions.

If you use rechargeable batteries in your transmitter, be aware that when they begin to lose their charge, they lose power much more quickly than regular alkaline batteries.

Caution: Discontinue running your T-Maxx 2.5R at the first sign of weak batteries (flashing red light) to avoid losing control.

i If the power indicator doesn't light red, check the polarity of the batteries. Check rechargeable batteries for a full charge.

! Direct the battery wires through the slot in the battery cover. If the wires are not properly routed, they may become broken or shorted, causing radio system failure and loss of control. If you use rechargeable batteries in your receiver, be aware that when they begin to lose their charge, they lose power much more quickly than regular alkaline batteries. Signs of weak receiver batteries include sluggish steering response and shortened radio range. **Caution:** Discontinue running your T-Maxx 2.5R at the first sign of weak batteries to avoid losing control.

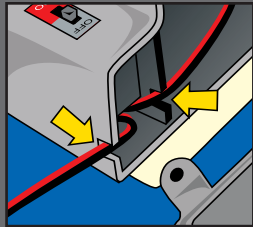

i If the radio system doesn't appear to work when the transmitter and receiver switches are turned on, check for correct battery installation.

INSTALLING RECEIVER BATTERIES

The radio receiver in your T-Maxx 2.5R uses 4 AA batteries. The battery holder for the receiver batteries is located underneath the battery cover. The battery cover can be identified by the on/off switch.

1. Remove the battery cover by removing the two 3x10mm buttonhead cap screws from the cover.
2. Remove the battery holder and install 4 AA alkaline batteries. Make careful note of the battery polarity by comparing against the diagrams in the battery holder.
3. Insert the battery holder into the battery cover.
4. Reinstall the battery cover and secure with the screws (see sidebar!).

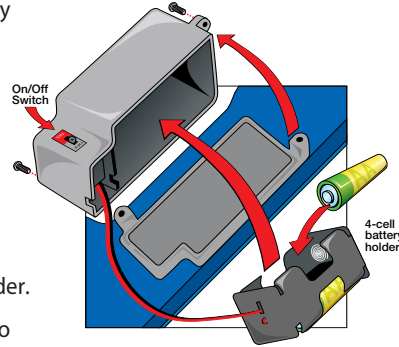

To prevent losing control of your model, it is important to stop at the first sign of weak receiver batteries. Visible warning signals include sluggish steering response and shortened radio range.

In addition, the Optidrive is equipped with a low-voltage indicator and a failsafe circuit. When the voltage of the receiver batteries drops below 4.3 volts, the "Function" LED on the OptiDrive will flash red. If the voltage drops below 4.3 volts for more than 2 seconds, the OptiDrive ignores throttle and shift signals and applies 25% brakes (failsafe mode). Steering will still be operational and the "Function" LED on the OptiDrive will flash red. The OptiDrive will stay in failsafe mode until the power is turned off or the receiver battery voltage rises above 4.3 volts for more than 2 seconds. Anytime the "Function" LED flashes red, it is time to stop and install new batteries (or recharge your battery pack if equipped). Do not try to continue running your model with weak receiver batteries on board.

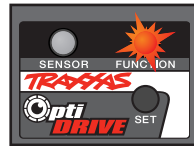

Traxxas TRX Power System (optional)



The optional Traxxas TRX Power System can be purchased separately to power the radio system in the T-Maxx 2.5R. Benefits include the economy of a rechargeable 5-cell nickel metal hydride (NiMH) battery pack that replaces AA alkaline batteries, and increased voltage for dramatically improved servo performance. The TRX Power Charger (Part #3030X) is a peak-detecting unit that will charge the RX Power

Pack (Part #3036 flat pack or #3037 hump pack) in about one hour. The peak detection circuitry automatically shuts off the charger when the maximum charge has been achieved. The TRX Power Charger also includes a 7.2V adapter for charging 7.2V EZ-Start batteries. The TRX Power Charger can operate on either AC or DC power. A special wiring harness for T-Maxx (Traxxas part #3034) that includes a handy external charging jack is required.



The optional DC car adapter (Part #3032) features a tangle-free, extra long wire and integrated fuse. The long charging cord allows the model to remain outside the car while charging. **Caution!** Never charge batteries in an enclosed car interior or while driving. Never leave charging batteries unattended. Monitor them closely.

Traxxas' integrated TRX Power System is the easiest way to add the power and economy of rechargeable batteries to your T-Maxx 2.5R. Consult your hobby dealer for purchasing information.

SETTING UP THE ANTENNA

1. Locate the black antenna wire that exits the top of the receiver box.
2. Pull the wire straight with your fingers and then insert the end of the wire into one end of the antenna tube (the antenna tube, tip, crimp nut and sleeve are located in the documents bag). Push the wire all the way through the antenna tube.
3. Insert the base of the tube into the antenna post. Take care not to crimp the antenna wire.
4. Slide the crimp nut over the antenna tube and screw it onto the antenna post. Use the supplied tool to tighten the crimp nut on the post just until the antenna tube is securely in place. Do not over tighten or crush the antenna wire against the receiver box.
5. Fold the top of the antenna wire over the top of the antenna tube. Slide the antenna sleeve over the tube to retain the antenna wire. Now slide the antenna tip onto the top of the antenna tube. Never cut or shorten the antenna wire.
6. On the transmitter, always fully extend the telescoping antenna when running your T-Maxx 2.5R. Make a habit of holding the transmitter so the antenna points straight up.

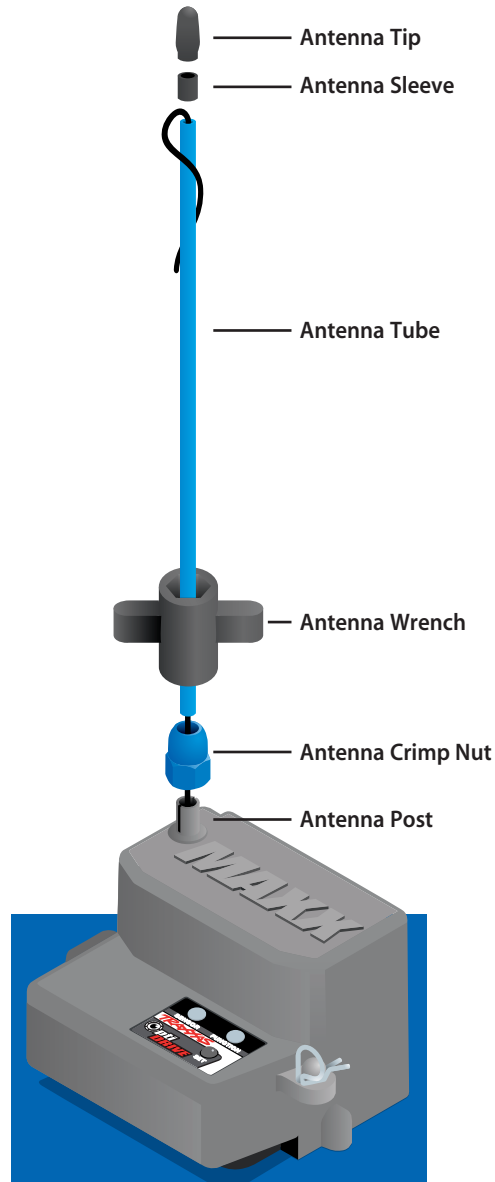

i Spray a little window cleaner on the antenna wire to make it easier to push through the antenna tube.

! Don't shorten the length of the antenna wire. Its length is tuned to the frequency band; cutting it could severely shorten the radio system's range.

! Don't push the transmitter antenna down from the top. Pull it down from the bottom, one segment at a time, to prevent binding and kinking the antenna mast.

TQ-3 RADIO SYSTEM CONTROLS

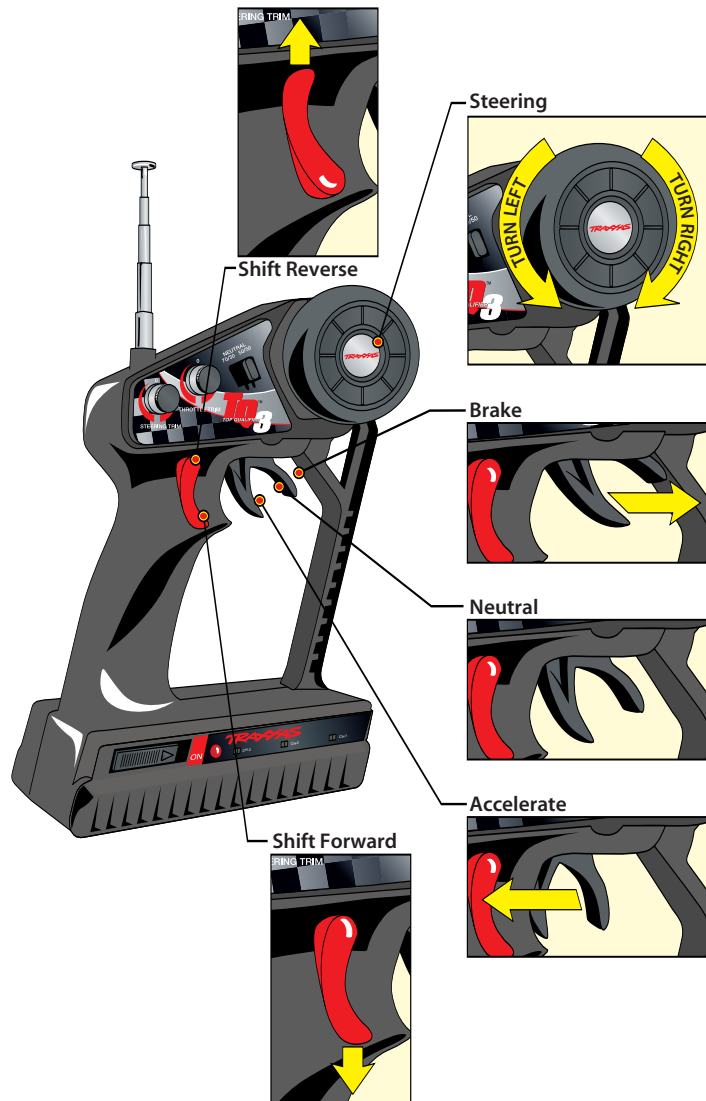

TQ-3 RADIO SYSTEM ADJUSTMENTS

In addition to the electronic throttle and steering trim controls, your radio system features throttle neutral adjustment and servo reversing switches.

Throttle Neutral Adjustment

The throttle neutral adjustment is located on the transmitter face and controls the forward/reverse travel of the throttle trigger. Change the adjustment by pressing the button and sliding it to the desired position. There are two settings available:

- ☉ 50/50: Allows equal travel for both acceleration and braking.
- ☉ 70/30: Allows more throttle travel (70%) and less brake travel (30%).

50/50 is the required setting for T-Maxx 2.5R with the TRX 2.5R Racing Engine.

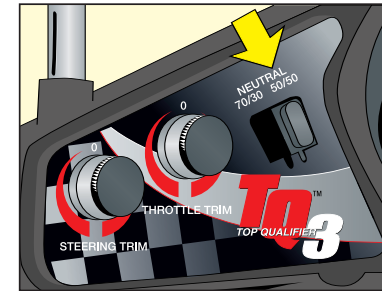

Electronic Throttle Trim

The electronic throttle trim located on the face of the transmitter adjusts the neutral (center) point of the throttle servo when the servo is at rest. This control has been preset for you at the factory. If necessary, adjust the control so that the carburetor is at idle, and the brakes are not applied (the model will roll freely). Do not use the throttle trim to raise or lower the engine idle speed. Make the idle speed adjustment on the carburetor.

Electronic Steering Trim

The electronic steering trim located on the face of the transmitter adjusts the neutral (center) point of the steering servos when the servos are at rest. Adjust this control to make the model drive straight with no steering input at the wheel.

Servo Reversing Switches

The servo reversing switches are located on the front of the transmitter, next to the on/off switch. Moving a switch reverses the direction of the corresponding servo. Each switch corresponds to a channel, as shown below. For example, if you turn the steering wheel to the right and your front wheels turn left, you would move the channel 1 switch to correct the servo direction. It may be necessary to adjust the corresponding trim control after moving a switch. The default position for the servo reversing switches is shown.



TQ-3 CHANNEL TO SERVO CHART

CHANNEL	SERVO
1	STEERING
2	THROTTLE AND BRAKING
3	SHIFTING

Programming the OptiDrive™ ESM

The OptiDrive ESM electronically monitors vehicle speed and controls forward and reverse shifting. Controlling the shift action electronically rather than by mechanical systems reduces the number of components in the transmission. The transmission weighs less, there is lower rotational mass for quicker acceleration, and constant drive engagement for smooth power delivery.



The OptiDrive module prevents the transmission from changing directions while the truck is in motion. The truck must be completely stopped to change directions, regardless of the position of the shift selector switch on the transmitter. The OptiDrive module is preset at the factory. If the transmitter throttle trim adjustment is changed, then the OptiDrive module will need to be re-programmed.

1. The engine must be shut off. The radio system must be on (receiver and transmitter).

2. Set the TQ-3 Transmitter to its factory default shift settings:

- Set the THROTTLE NEUTRAL switch to the 50/50 setting.
- Set the THROTTLE TRIM to the center "0" setting, then adjust the throttle linkage until the carburetor closes.
- Set the CHANNEL 2 SERVO REVERSING SWITCH to the right position.
- Set the CHANNEL 3 SERVO REVERSING SWITCH to the right position.
- DO NOT change the position of any of the servo reversing switches after programming the OptiDrive. If settings were changed after programming the OptiDrive, it will have to be reprogrammed.

3. With the throttle at neutral, press and hold the SET button until the Function LED flashes green twice and then release the button immediately. You are now in programming mode.

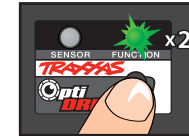

4. Pull the transmitter throttle trigger to the full throttle position. Hold it there until the Function LED flashes green three times. **Note:** The throttle servo will not move during programming even though it is connected to the controller.

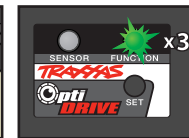

5. Release the transmitter throttle trigger allowing it to return to neutral. The Function LED will turn solid green, indicating that the shifting servo is OK to shift and the programming has been completed. The controller is now programmed and ready to go!

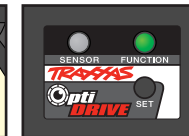

- If the transmitter throttle settings are changed, it will be necessary to complete the programming sequence again.
- If the SET button is released before the Function LED flashes green twice in step 3, the OptiDrive will return to the normal operation mode.
- If you experience any problems during programming, turn the receiver off, then on again, and repeat the programming steps.

For instructions on how to use the OptiDrive with aftermarket radio systems, or to access advanced programming options, visit our website, www.Traxxas.com.



Large adjustments to the throttle trim and/or throttle linkage may require re-setting the OptiDrive to maintain proper shifting action.



For transmission durability, the OptiDrive ESM limits the model's reverse speed to about 70% of full throttle. If settings are changed, and you notice a decrease in forward top speed, you could have the OptiDrive system reversed. Return the TQ-3 servo-reversing switches for channels two and three back to their default settings and re-program the OptiDrive Module. For programming with aftermarket radio systems, please see our website.

OptiDrive Operation



• Green "Function"
Shift allowed



• Red flashing "Function"
Low battery, see pg. 12



• Red "Sensor"
a) Sensor, throttle or shift circuit is broken. Possible disconnected or broken sensor, throttle or shift wires. Possible damaged sensor.
b) Receiver has lost signal from the transmitter, the OptiDrive has entered fail-safe (throttle and shift servos become unresponsive).



• Blue flashing "Sensor"
Normal operation as vehicle moves. Indicates signal pulse from sensor. Depending on the rotor position, solid blue or off when vehicle is at rest.



Remember, always turn the TQ-3 transmitter *on first* and *off last* to avoid damage to your T-Maxx 2.5R. Never turn the radio off while the engine is running.

TQ-3 RADIO SYSTEM RULES

- Each time you prepare to run your T-Maxx 2.5R, you must clear your frequency to be sure no one else in the area is using the same channel as you.

There are six possible channels, numbered 1 through 6. Each is represented by a color. Look at the crystal plugged into the back of your transmitter to determine which channel your truck is assigned to.

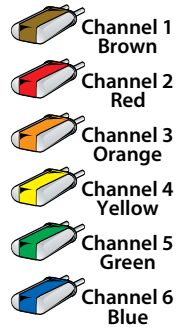

- Always turn your TQ-3 transmitter on first and off last. This procedure will help to prevent your T-Maxx 2.5R from receiving stray signals from another transmitter, or other source, and running out of control.

- Always have the transmitter and receiver turned on before you start the engine. Never turn the radio system off while the engine is running. The on/off switch in the model only turns the receiver on and off. It does not turn off the engine.
- Always use new or freshly charged batteries for the transmitter, and make sure the receiver batteries are fresh. The function light on the OptiDrive will flash red if the receiver batteries become weak. Weak batteries will limit the radio signal between the receiver and the transmitter. Loss of the radio signal can cause you to lose control of your T-Maxx 2.5R.

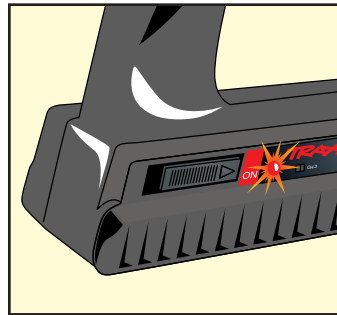

1

Always turn your transmitter on first.

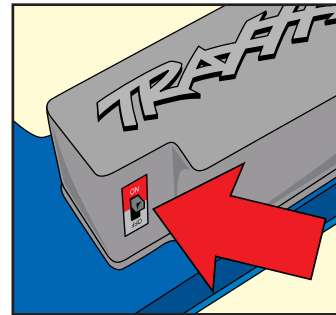

2

Always turn your receiver on second.

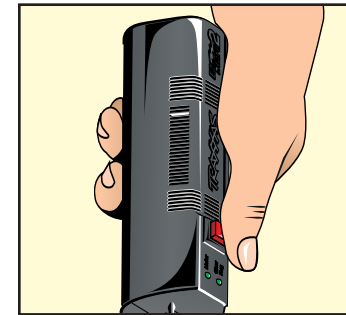

3

Then start your engine.



USING THE TQ-3 RADIO SYSTEM

The TQ-3 Radio System was pre-adjusted at the factory. The adjustment should be checked before running the model, in case of movement during shipping. Here's how:

1. Fully extend the chrome antenna mast on the transmitter and turn the switch on. The red indicator light on the transmitter should be solid red (not flashing).
2. Turn on the receiver switch in the model. The switch is located in the top of the radio compartment. The function light on the OptiDrive ESM should be green. A red flashing LED indicates low voltage in the receiver batteries. The sensor LED is intermittent depending on the rotor position.
3. Position T-Maxx 2.5R so that its front wheels are off the ground.
4. Turn the steering wheel on the transmitter back and forth and check for rapid operation of the steering servo. Also, check that the steering mechanism is not loose or binding. If the steering operates slowly, then make sure you have fresh receiver batteries .
5. When looking down at model, the front wheels should be pointing straight ahead. If the wheels are turned slightly to the left or right, slowly adjust the steering trim control on the transmitter until they are pointing straight ahead.
6. Operate the throttle trigger on the transmitter and check for rapid operation of the throttle servo. When the throttle trigger is pulled back, the carburetor should open (slide moves out). When the throttle trigger is pushed all the way forward, the brake should lock.

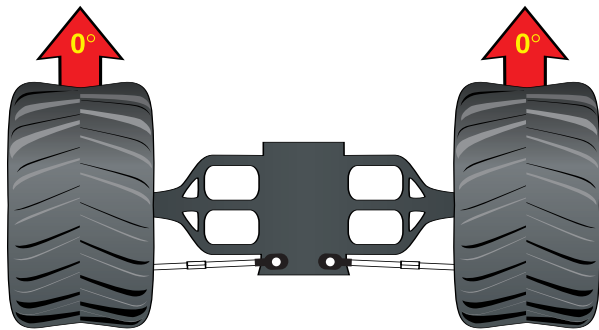

7. Operate the shift button on the transmitter and check for rapid operation of the shifting servo. Push the shift button down for forward. The servo will operate the spring-loaded shift mechanism and you will hear the transmission click into forward. Push the shift button up for reverse and you will again hear the transmission click and shift into gear.
8. Once adjustments are made, turn off the receiver on your T-Maxx 2.5R, followed by the hand-held transmitter.

RANGE-TESTING THE TQ-3 RADIO SYSTEM

Before each running session with your T-Maxx 2.5R, you should range-test your radio system to ensure that it operates properly.

1. Turn on the radio system and check its operation as described in the previous section (Using the TQ-3 Radio System).
2. Have a friend hold the model with the engine off.
3. Make sure your transmitter antenna is fully extended, and then walk away from the model with the transmitter until you reach the farthest distance you plan to operate the model.
4. Operate the controls on the transmitter once again to be sure that the model responds correctly.
5. Do not attempt to operate the model if there is any problem with the radio system or any external interference with your radio signal at your location.

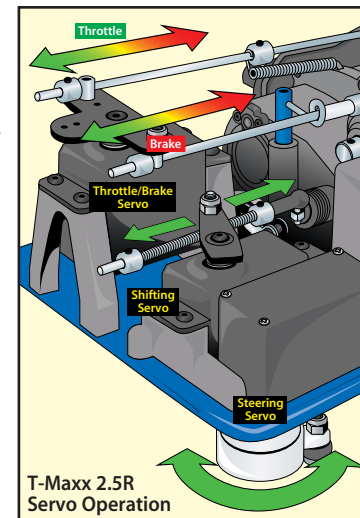

! When the engine is running, don't use the throttle trim on the transmitter to adjust the engine idle speed. Instead, use the idle speed adjustment on the carburetor. Do not use the throttle trim as an "idle up" function for starting or you could affect the OptiDrive programming

! Don't attempt to operate your T-Maxx 2.5R if there are any problems with your radio system or radio interference at your location.

THE TRX 2.5R RACING ENGINE



Traxxas strongly discourages changing or modifying any part of the TRX 2.5R Racing Engine. Old tech tips and tricks that may have boosted the power of other engines could seriously diminish the performance of the TRX 2.5R Racing Engine.

There's more advanced thinking, development and testing in the stock parts of your TRX 2.5R Racing Engine than in many aftermarket manufacturer's performance parts. The TRX 2.5R Racing Engine is already the most powerful engine in its class and simply will not benefit from average, low-tech, aftermarket bolt on performance items.

INTRODUCTION

There's nothing like the TRX 2.5R Racing Engine in your new T-Maxx 2.5R. The TRX 2.5R Racing Engine is a specialty high-performance racing engine. Its impressive performance is the result of years of focused engineering development, and thousands of hours of controlled testing and rigorous real-world running. It offers unprecedented power and performance that turns ready-to-run into Ready-To-Race®.

The TRX 2.5R Racing Engine takes a total-system approach. Each part of the engine, from the air filter to the exhaust tip, is carefully engineered to work in harmony with other engine components. Each part complements the next, to extract maximum power. The TRX 2.5R Racing Engine is designed to be tolerant of variations in tuning, and to run successfully through a wide range of variable atmospheric conditions such as changes in temperature, humidity, and altitude.

In order to get the longest engine life and keep the TRX 2.5R Racing Engine in top running condition, it is very important to perform regular routine maintenance. **The number one cause of premature engine wear and failure is lack of care and maintenance!**

BREAK IN

The TRX 2.5R Racing Engine is manufactured to exacting tolerances and requires a specially-designed break-in procedure to accomplish the final precision fitting of the internal engine components. It is very important that you follow the new break-in procedure as closely as possible to achieve the best performance and longest life from your TRX 2.5R Racing Engine. Engine break-in will take between one and two hours. Old style break-in procedures, such as idling the engine on the bench for several tanks of fuel or simply running the engine with a very rich fuel mixture for the first 4 tanks of fuel, will not achieve the best results. Follow the easy steps in this manual.

AIR FILTER MAINTENANCE

A clean air filter is critical for long engine life. Due to the high-performance nature of the TRX 2.5R Racing Engine, a tremendous amount of vacuum is created to move a large volume of high-velocity air through the carburetor. Dirt is the worst enemy to your engine. Clean the air filter after each hour of running to prevent sucking dirt into the engine. Extra pre-lubed filter elements have been provided to encourage you to maintain your air filter.



AFTER-RUN MAINTENANCE

Perform after-run maintenance on the engine to prevent corrosion from building up on the internal engine components. The fuel naturally attracts moisture and corrosion can build up very quickly inside the engine if it is not prevented.

A few minutes spent before and after each time you run your model will allow you to enjoy it for a long time to come. Read on for more exciting details about your new engine.

TRX 2.5R RACING ENGINE ILLUSTRATED

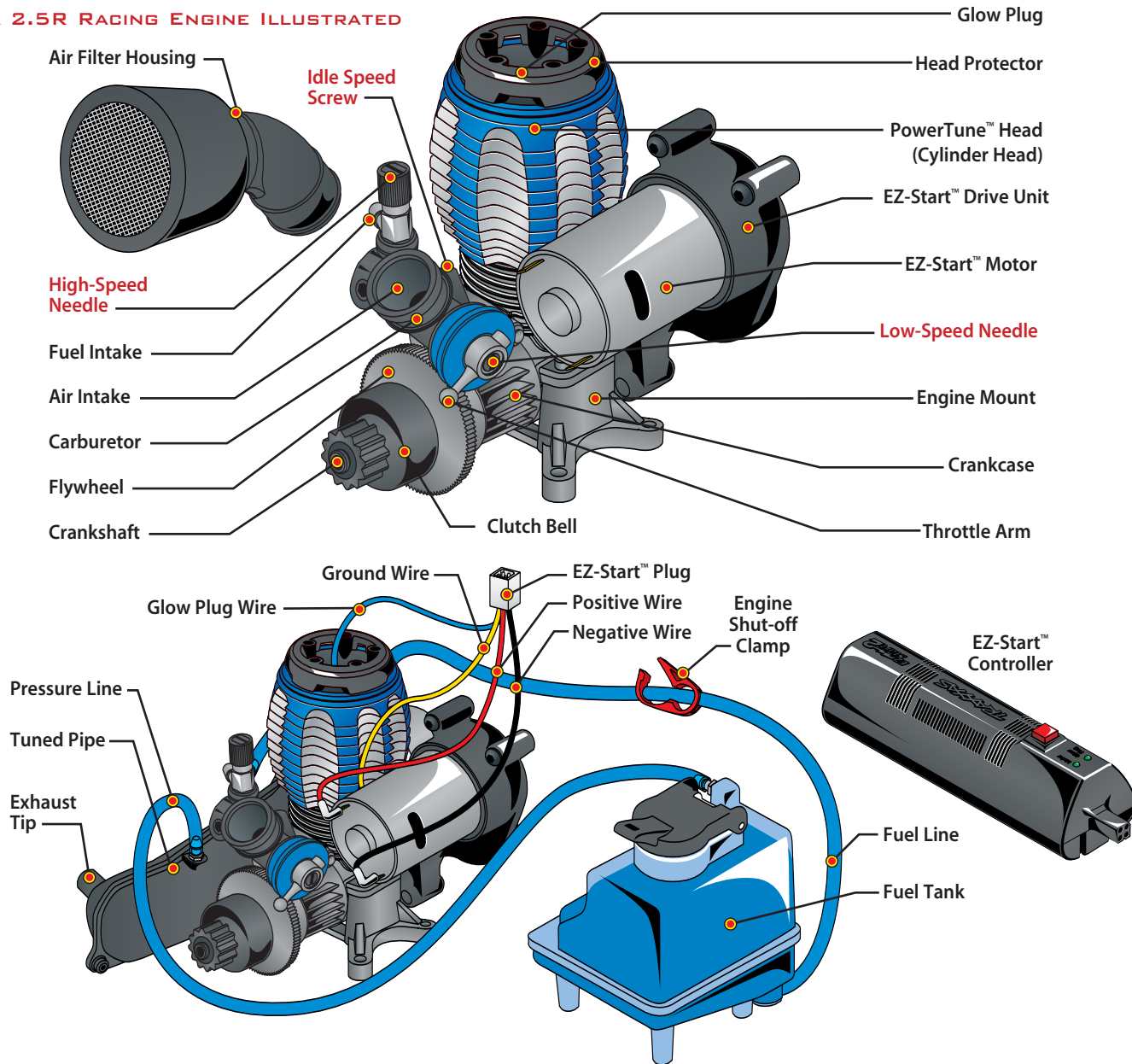

TERMS TO KNOW

You'll find these Nitro R/C engine terms throughout this section of the manual.

.15 - .15 or "15" refers to the displacement of the engine. The TRX 2.5 Racing Engine is .15 cubic inches or 2.5 cubic centimeters (cc). The name "TRX 2.5" is derived from the cc measurement.

ABC - Abbreviation for aluminum, brass, and chrome. Refers to engine construction that consists of an aluminum piston that slides in a chrome-plated brass sleeve. The TRX 2.5R uses ABC construction.

Air filter - The air filter sits atop the carburetor and prevents harmful dust and dirt from entering the engine. Dirt ingestion is the number one cause of premature engine failure so the engine should never be run without the air filter in place.

BDC - Bottom dead center. The bottom-most position of the engine piston stroke.

Break-in - Break-in is the procedure for running a brand new engine according to specific instructions. This correctly prepares the engine for normal running. The break-in procedure can be different for different makes of engines. Follow the Traxxas directions for break-in exactly.

Carb - Abbreviation for carburetor.

Carburetor - The carburetor atomizes (mixes) the fuel with the air so that the engine can burn it. There are two types of carburetors; slide carbs and barrel carbs. The TRX 2.5R uses the superior slide carburetor design.

Clean-out - Cleaning-out is a condition that occurs when the engine is accelerating and the fuel mixture becomes sufficiently lean to allow the engine to continue into its upper rpm power band. It is usually characterized by a noticeable decrease in blue exhaust smoke and a dramatic increase in engine speed.

Combustion chamber - The combustion chamber is machined into the bottom of the cylinder head. This is where the glow plug ignites the fuel. The shape of the combustion chamber is designed to promote more efficient burning of the fuel.

Connecting rod - The connecting rod transfers the piston motion to the crankshaft. The TRX 2.5R Racing Engine uses a "knife-edged" connecting rod. The aerodynamic, sharpened edges allow it to "slice" through the pressurized air/fuel mixture inside the crankcase.

Crankcase - The engine's "body" that contains all of the running mechanical components.

Crankshaft - The main shaft of the engine that holds the reciprocating assembly.

Cooling fins - The cooling fins are milled into the cylinder head and crankcase and cause heat to be drawn away from the engine. Heat is removed when it dissipates into the air passing across the cooling fins. It is important to keep the fins clean of dirt and debris for maximum cooling efficiency.

Cylinder head (head) - The finned aluminum part on top of the engine that is responsible for dissipating most of the engine's heat. The combustion chamber is machined into the bottom of the head.

Dyno - Abbreviation for dynamometer. A precise piece of testing equipment that accurately measures engine power and torque output over the engine's entire rpm range.

EZ-Start - Traxxas on-board electric starting system. The system consists of a hand held starter control unit and an on-board gearbox with an electric motor to spin the engine.

Filter foam - The oiled foam element inside the air filter housing. The filter foam in the TRX 2.5R must be thoroughly cleaned and re-oiled after every hour of run time.

Fit - Usually refers to the fit of the piston and sleeve. If the fit is tight, the piston will feel very tight at top of the sleeve (top dead center), and the engine will have good sealing and compression. If the fit is loose, compression will be low and both the piston and sleeve should be replaced.

Flame-out - Occurs when the engine stops running at high rpm. Usually the fault of an excessively lean fuel mixture or glow plug failure.

Fuel - (10%, 20%, 33%) The TRX 2.5R must have model engine fuel to run. Traxxas Top Fuel™ is recommended. Fuel is sold in quarts and gallons from hobby dealers. The 10%, 20% and 33% labeling refers to the percentage of nitromethane contained in the fuel.

Fuel mixture - The ratio of fuel to air as determined by the needle settings of the carburetor.

Fuel tubing (fuel line) - The thick silicone tubing that carries fuel from the fuel tank to the carburetor.

Glow plug - The glow plug is located in the cylinder head at the top of the combustion chamber. It contains an element that glows red hot when voltage is applied. When the engine is being started, the heat from the glow plug ignites the fuel mixture and starts the combustion process.

Glow plug driver - This tool clips onto the glow plug and supplies the required voltage to light the glow plug element. It is also called an igniter. EZ-Start equipped engines do not require this separate tool.

Header - The aluminum tube that connects the exhaust system to the engine exhaust port. The length and diameter of the header must be carefully selected to extract the most power from the engine.

High-speed needle (HSN) - Adjusts the carburetors fuel/air mixture at high throttle openings.

Idle speed - The speed (rpm) the engine runs at when the transmitter's throttle trigger is at neutral.

Idle speed screw (ISS) - Located on the carburetor body. This screw adjusts the idle rpm of the engine.

Lean - A running condition where the engine is not getting enough fuel (for the available air). Symptoms include engine overheating, or the engine runs for a short time and then stalls, particularly at high speed. This is a dangerous condition that should be corrected immediately or it can ruin your engine.

Leaning the mixture - Turning either the high-speed and/or low-speed needle(s) clockwise to decrease the amount of fuel the engine receives.

Low-speed needle (LSN) - Needle valve that controls the fuel mixture at low throttle openings.

Needle valve - Valve consisting of a tapered needle that closes against a corresponding seat to regulate fuel flow.

Nitro - Abbreviation for nitromethane, a component of model engine fuel that improves fuel combustion and power output. Nitro also refers to a class of R/C powered by model engines instead of electric.

Nitro content - The amount of nitromethane used in the fuel. Usually measured as a percentage of the total fuel volume. Traxxas engines are optimized to use 10-20% nitro. 33% nitro may be used for racing.

Nitromethane - Nitromethane is a component in the fuel that increases power from the combustion process up to a point. Engines are generally optimized to use a range of nitro content for the best power.

O-ring - Rubber "O"-shaped ring used as a sealing gasket.

Pipe - Abbreviation for the tuned exhaust pipe on a nitro engine. See "Tuned Pipe".

Piston - The piston is the internal engine part that is attached to the upper end of the connecting rod and moves up and down in the cylinder sleeve. The precise fit between the piston and the sleeve creates a seal that allows the engine to have the required compression for combustion.

Port - Ports are openings in the sleeve that allow atomized fuel to enter the combustion chamber and burned exhaust gases to exit. The shape and location of the ports are a large factor in controlling the engine timing and power output.

Priming - Manually causing fuel to move from the fuel tank up to the carburetor. This is sometimes necessary after the engine has been sitting for a long period of time and all of the fuel has drained back to the tank. On a Traxxas model this is done by holding your finger over the exhaust tip for one or two seconds while the engine is starting.

Punch - A term that refers to how quickly the model responds to throttle input or how quickly it accelerates.

Rich - A running condition where the engine is getting too much fuel for the available air. It is better to run an engine slightly rich to increase engine life. Excessively rich mixtures cause the engine to have sluggish performance with exaggerated blue smoke and unburned fuel coming from the exhaust.

rpm - Abbreviation for revolutions per minute (how many times the engine crankshaft spins in a minute).

Sleeve - Internal engine part that contains the piston. The precise fit between the sleeve and the piston creates a seal that allows engine to have the required compression for combustion. The sleeve in a TRX engine is made of brass and is then hard-chrome plated.

Slide carburetor - The throttle on a slide carburetor closes and opens by sliding a barrel in and out of the carburetor body. This type of carburetor is preferred for performance use because it provides a less restrictive "straight-through" air path than the barrel carburetor design.

Stall - When the engine stops running, usually due to an incorrect fuel mixture setting or running out of fuel.

TDC - Top dead center. The top-most position of the engine piston stroke.

Tuned pipe - The tuned exhaust pipe usually consists of a specially-shaped metal or composite chamber with baffles that is designed to enhance the power output of the engine.

Wear-in - Fitment process that occurs during engine break-in where internal engine parts develop an even more precise matched fit through actual use under controlled circumstances.

WOT - Abbreviation for wide-open throttle.



DANGER! Model engine fuel is poisonous to humans and animals. Drinking the fuel can cause blindness and death. Handle with care and respect. Keep it out of reach of small children at all times! While driving, do not leave your fuel dispensing bottle on the ground where a child could have access to it. Follow fuel label warnings.

THE FUEL

Use the Right Fuel

It's imperative that you use the correct fuel in your TRX 2.5R Racing Engine for maximum performance and engine life. Traxxas Top Fuel™ should be used to ensure correct engine lubrication, performance, and ease of tuning. Traxxas Top Fuel has been proven in thousands of engines, so you can count on it every day for great performance.



- ☉ Top Fuel is the only fuel which is 100% certified for use in Traxxas engines.
- ☉ Traxxas Top Fuel is made with just the right balance of the highest grade natural and synthetic lubricants to allow excellent throttle response and the best top-end performance, without sacrificing long-term durability.
- ☉ All of the components in the fuel are carefully selected from the best materials available and then custom blended to match the metallurgy and temperature characteristics of Traxxas engines.

You may use 10%, 20% or 33% nitro-content fuel. Try to use the same percentage all the time, avoid switching back and forth between fuels. We recommend that if you break in your engine on 20% fuel that you stick with that percentage. If you do move to a higher or lower percentage, make sure you readjust your fuel mixture to compensate (see below).

Choosing a Nitro Percentage

A commonly asked question is "what is the difference between 10%, 20%, and 33% fuels?" Increasing the nitro in the fuel is almost like adding extra oxygen to the combustion process. It burns more efficiently, improves combustion, and delivers more power. When increased nitro is used, more of the other fuel components are then required inside the combustion chamber to maintain the perfect air/fuel ratio. Therefore, overall fuel mixtures need to be richened slightly (on the high speed needle, about 3/4 of a turn counterclockwise when changing from 20% to 33%, about 1/2 of a turn counterclockwise when changing from 10% to 20%). This allows greater fuel flow through the engine and promotes cooler running, even at the maximum lean settings.

If 33% improves power, then it seems that the highest nitro content available (beyond 33%) should always be used in the engine. In reality, there are practical limitations. Engines are designed to run best within a range of nitro percentages. How the engine is ported, the size of the combustion chamber and other factors determine how much nitro can be

efficiently used in the engine. The TRX 2.5R Racing Engine responds exceptionally well to a maximum of 33% nitro, returning cooler temps, more power, and a smoother throttle response. For those who want to run higher nitro, 33% Top Fuel is the optimum nitro percentage for the TRX 2.5R Racing Engine. Increasing the nitro beyond 33% can introduce the need for engine modifications (ports, head shimming, etc.) to avoid starting and tuning difficulties. There are limits to how much nitro an engine can effectively use to make more power. Lower nitro percentages have their own advantages. Nitro is an expensive component in the fuel so 10% nitro blend is more economical for the sport user. 10% also provides greater latitude with the needle settings for easier tuning.

When using Traxxas Top Fuel, using higher nitro percentages does not cause the engine to wear out faster. 33% Top Fuel contains the same quality lubrication package as 10 and 20% Top Fuel. Some non-Traxxas high-percentage nitro racing fuels do sacrifice some lubrication in attempts to increase performance. We urge you to not take chances with your engine investment and use Top Fuel for consistent performance and long engine life.

What about Other Fuels?

Can other brands of fuel be used besides Top Fuel? There are other fuels that can provide satisfactory performance; however there could be long-term costs in the form of decreased engine performance, loss of tuning ease, and shorter engine life. Only use fuels that contain both castor and synthetic oil.

Everyone has an opinion or a claim to make about fuel. The engineering team at Traxxas has spent years developing TRX Racing Engines. No one knows more about the specific fuel requirements of Traxxas engines, than Traxxas engineers. We strongly urge you not to take chances with your engine investment and use the Traxxas fuel made for the TRX 2.5R Racing Engine.

Handling the Fuel

- ☉ Follow all directions and warnings on the fuel can.
- ☉ Keep the fuel tightly capped at all times. Some components in the fuel can evaporate very quickly and upset the balance of the fuel.
- ☉ Do not store unused fuel in the fuel dispenser. Immediately return fresh unused fuel back into the fuel can.
- ☉ Do not mix old and new fuel. Never mix different fuel brands together.
- ☉ Store the fuel in a cool dry location, away from any source of heat, ignition, or combustion.
- ☉ Read and follow the safety precautions on page 4 in this manual.

Filling the Fuel Tank

Use a fuel dispensing bottle (Traxxas Top Fueler, part# 5001) to put fuel into the T-Maxx's fuel tank. To fill the fuel bottle, squeeze the air out, insert the dispenser tip into the fuel can, and release your grip on the bottle. As the bottle expands, fuel will be drawn into it.

To fill your model flip up the spring-loaded cap on the fuel tank, insert the tip of the fuel bottle, and squeeze to dispense the fuel. Fill the tank until the fuel level reaches the base of the filler neck. Close the fuel tank lid, making sure it closes tightly.

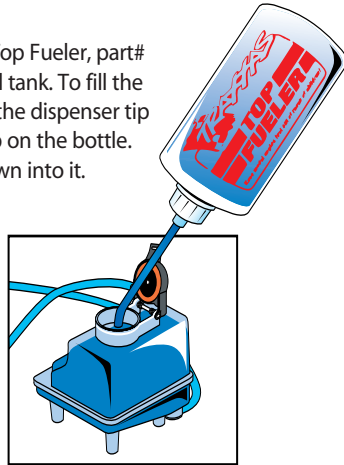

Fuel Tank Seal Adjustment

The rubber seal on the fuel tank is important to the function of the engine. The fuel tank is pressurized by the exhaust system to provide reliable fuel flow. If the tank lid does not seal properly, an air leak will be created that can cause your engine to run erratically and be difficult to start. If necessary, the rubber O-ring tank seal can be adjusted for improved sealing by tightening the screw on the underside of the tank lid.

THE AIR FILTER

The TRX 2.5R Racing Engine air filter is specifically designed to deliver maximum performance while protecting your engine from dust and dirt. Use only the supplied filter. **You will not improve engine performance by switching to an aftermarket filter**, and you may risk engine damage due to poor filtration.

The TRX 2.5R Racing Engine air filter assembly consists of 3 pieces:

1. A rubber filter base.
2. A plastic housing consisting of a permanently assembled mesh cap and body.
3. An oiled foam element.

You must clean the filter after every hour of run time, even if the filter looks clean. This includes the break-in time. Clean your air filter after break-in. Dust (which is often too fine to see) and dirt constantly move through the filter anytime the engine is running. Even if you can't see dirt on the filter, it is present inside the foam after any amount of run time. If

you exceed the recommended cleaning intervals, your engine will be damaged. Engine damage or wear due to dirt ingestion is easy to detect, and one of the top causes of premature engine failure.

Air Filter Cleaning Instructions

1. Remove the air filter from the carburetor bore by pulling the entire filter assembly firmly to the side to release it. **Do not pull straight up.**
2. Disassemble the filter. Pull the rubber air filter neck out of the filter body. With the base removed, the foam element is visible in the bottom of the filter body. Pull out the foam element.
3. Clean the filter parts by thoroughly washing all three pieces of the filter assembly in hot soapy water (dishwashing detergent works well). Repeat twice.
4. Thoroughly dry the parts with a clean towel or compressed air. Remember to wear your safety glasses when working with compressed air.
5. Oil the foam element with foam filter oil. Use the supplied Traxxas filter oil (part# 5263) or a high-quality, special-purpose foam filter oil like what is used for off-road motorcycle and ATV engines. This type of filter oil is available at motorcycle pro-shops. Apply 30 drops of the Traxxas filter oil evenly to the top, bottom and sides of the filter element (30 total drops divided among the 3 surfaces). Squeeze the filter element repeatedly to help spread the oil throughout. The filter element should be evenly colored by the oil. Even color indicates that the oil is distributed evenly. **Do not squeeze out excess oil.**
Note: Do not use the air filter oil for anything other than the air filter. It is not meant to be a lubricant.
6. Reassemble the filter and install it on the engine, making sure the rubber filter neck fits securely on the carburetor with no gaps or air leaks.

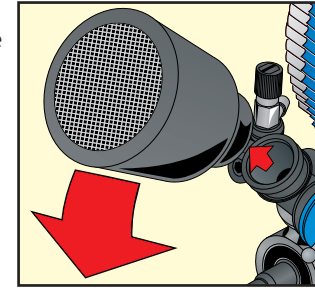



See page 32 for more information on how air density affects engine tuning.



A "turn" refers to tightening ("turning in") or loosening ("turning out") mixture needles. A "full turn" refers to turning the needle 360°, so a "1/2 turn" would be 180°, a "1/4 turn" would be 90°, and so on.

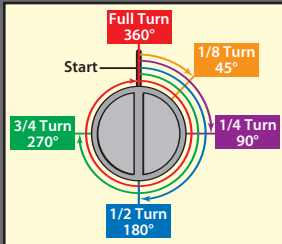

THE CARBURETOR

Understanding the Carburetor adjustments

The carburetor performs several functions. It controls the engine's speed by restricting the intake of air and fuel into the engine. It atomizes the fuel (suspends the fuel droplets in the air) and also controls the air/fuel ratio of the mixture entering the engine (how much air for a given amount of fuel).

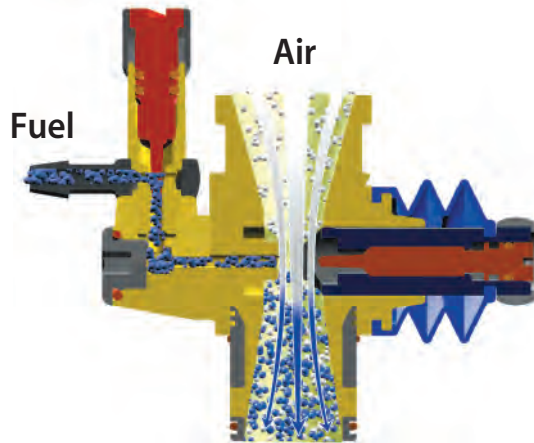

To help provide a better understanding of engine tuning and why it's necessary, the following is a brief explanation of the air/fuel combustion process that takes place inside the engine.

In order to create the cylinder pressure that results in power, the engine burns the air/fuel mixture. Both air and fuel, in correct amounts, are needed for proper combustion. It is the carburetor's job to mix the air and fuel together (atomize the fuel), in the correct proportion for the best possible combustion. This is the ideal air/fuel ratio. The ideal air/fuel ratio required for the engine remains roughly constant. Due to variations in atmospheric conditions (temperature, humidity, altitude etc.) fuel flow adjustment valves (called fuel mixture needles) are required to meter the fuel and maintain the ideal air/fuel ratio in these ever-changing conditions. For example, colder air is more dense (more air molecules) for a given volume of air and therefore requires more fuel (more fuel

molecules) to maintain the correct air/fuel ratio. Warmer air is less dense (fewer air molecules) and therefore needs less fuel to maintain the correct air/fuel ratio. The tuning needles are there to adjust how much fuel is made available for the carburetor to mix with the available air (atomization).

Cold Air (More Dense)



(Warm Air) Less Dense



THE FUEL MIXTURE NEEDLES

The amount of fuel metered and atomized by the carburetor is controlled by the two mixture needles, the high-speed needle and the low-speed needle. The low-speed needle is used to meter the fuel used by the engine at idle and low rpm (part-throttle) engine speed. The high-speed needle is used to meter the fuel when the throttle is open from part throttle to wide-open throttle (WOT). Two needles on the TRX 2.5R Racing Engine provide precise control of the air/fuel ratio across the engine's entire rpm range.

The maximum possible fuel flow is always controlled by the high-speed needle. It works like the main water valve on a garden hose. Turn it clockwise to close the valve, counter-clockwise to open it. When the throttle is at idle or partially open, the low-speed needle meters the fuel flow at the outlet (needle seat) where the fuel enters the carburetor venturi. This second valve acts like the spray nozzle at the end of the garden hose in our example. When you accelerate from idle, the throttle opens and the low-speed needle is pulled away from the needle seat. This allows more fuel to flow with the increased air flow. As the throttle

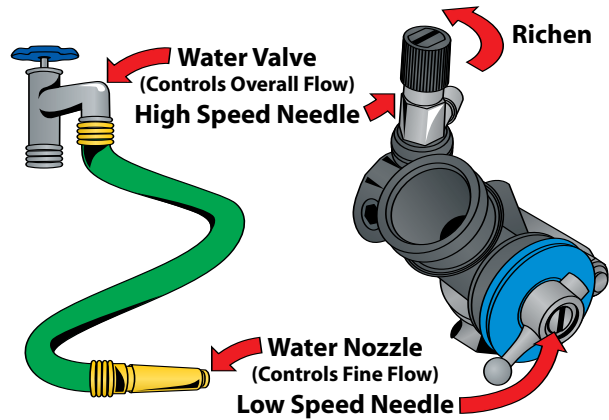

is increased, the low-speed needle is pulled completely away from the needle seat leaving it fully open. At that point, fuel metering is entirely controlled by the high-speed needle. Again, using our water hose example, when the spray nozzle at the end of our garden hose is fully open, then the main water valve can be used to adjust how fast the water flows.

The engine's performance is directly linked to the fuel mixture. Richening the fuel mixture increases the amount of fuel in the air/fuel mixture ratio and leaning the fuel mixture decreases the amount of fuel in the air/fuel mixture ratio.

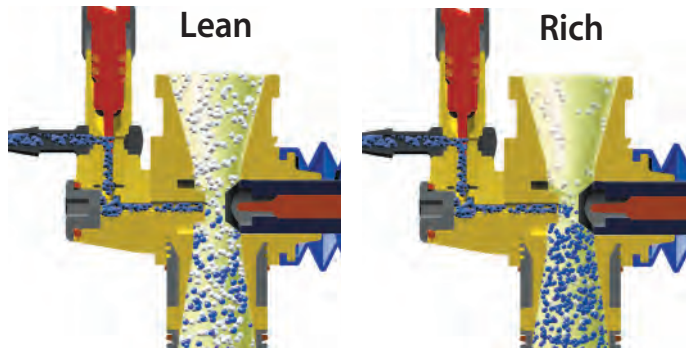

- ☉ Slightly lean fuel mixtures deliver stronger, more efficient combustion and more power, but with less lubrication.
- ☉ Slightly rich fuel mixtures deliver cooler running and more lubrication but with slightly less power.

Tuning the engine means finding the perfect balance between the two; excellent power to meet your needs while maintaining good lubrication for long engine life. **The optimal fuel mixture setting is rich** to provide a safety margin against having a lean condition if some variable changes (such as the temperature from one day to the next).

General fuel mixture settings are measured by the number of turns the needles are turned out from fully closed. The fuel mixture settings have been pre-set from the factory to typical break-in settings. Do not readjust your carburetor from the factory settings until after the engine is started and running, and you have been able to observe the engine running to assess what minor adjustments may be required to compensate for fuel, temperature, and altitude. Adjustments are usually made in 1/8 or 1/16-turn increments. If the engine sticks at TDC, see page 43 for instructions on freeing the engine.

The Idle Speed Adjustment

The idle speed screw controls the closed position of the throttle slide. When the throttle servo is in its neutral position, the throttle slide should be stopped against the idle adjustment screw. Always use the idle speed adjusting screw to control engine idle. Do not use the throttle trim on the transmitter to adjust idle speed. The idle speed should be set as low as possible and still maintain reliable running.

➔ See *Tuning Your TRX 2.5R Racing Engine* on page 31 for complete information on adjusting the air/fuel mixture and idle speed.

i **Factory Needle Settings**
If your factory preset carburetor adjustments have been tampered with, use the following settings:

- Set the high-speed needle to 4 turns out from closed.
- Set the low-speed needle so the screw head (red in Fig. A) is flush (even) with the end of the slide (yellow in Fig. A).

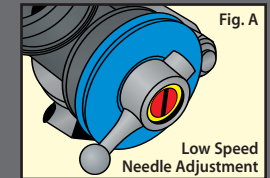

Always use the factory settings for initial starting. Only use these settings when the factory settings have been lost.

! Higher nitro requires a richer fuel mixture. When running 33% fuel, richen your high speed needle 3/4 turn if previously running 20% nitro and then re-tune the engine for maximum performance.



Use the Right Charger

The most convenient type of charger is an AC peak-detecting charger that plugs directly into an AC wall outlet, such as the TRX Power Charger (part #3030X, see page 12 for more info). It contains special peak-detection circuitry that automatically shuts the charger off when the battery is fully charged.

If you're using a 15-minute timed charger, always fully discharge the battery pack before each charge. Some high mAh battery packs (1500 mAh or higher) require more than the standard 15 minutes of charge time. If the battery pack is cold after 15 minutes of charging, add another 5 minutes of charge time. Closely monitor the battery pack and stop charging it when it begins to feel warm to the touch. Never leave a battery charging unattended. Always follow charger manufacturer's instructions.

Inexpensive overnight wall chargers may also be used.



THE TRAXXAS EZ-START™ ELECTRIC STARTING SYSTEM

The Traxxas EZ-Start brings the convenience of push-button electric engine starting to your T-Maxx 2.5R. The EZ-Start consists of a hand-held control unit and an on-board motorized starter.

- ☉ Power for the EZ-Start system comes from a 7.2-volt rechargeable battery pack installed in the hand-held control unit (battery not included).
- ☉ The engine glow plug is heated automatically by the EZ-Start system, eliminating the need to keep up with a separate glow plug igniter.
- ☉ The voltage to the glow plug is kept constant, regardless of the load placed on the starter by the starter motor.
- ☉ The "Glow Plug" LED (light emitting diode) on the control unit indicates glow plug continuity.
- ☉ The "Motor" LED indicates the status of the EZ-Start electric starter motor.
- ☉ The Cush Drive™ mechanism in the drive unit prevents damage to the gears caused by engine kickback.
- ☉ Smart Start™ protection circuitry prevents damage to the motor by cutting power if the load on the motor or other electronics exceeds safe limits.

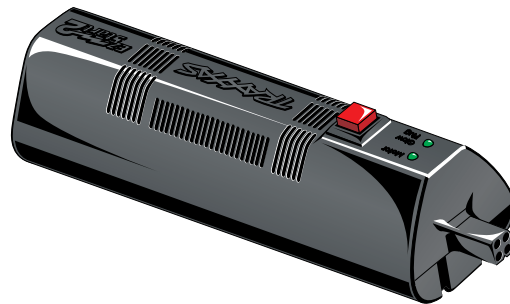

Installing the EZ-Start Battery

The EZ-Start system requires a fully charged 7.2-volt rechargeable NiCad or NiMH battery pack (not included). Use a charger (not included) designed for 7.2-volt battery packs. Charge the battery according to the charger manufacturer's directions.

1. Press the tab in the end of the battery compartment door to open. (A)
2. Plug a fully charged 7.2-volt battery pack into the connector inside. (B)
3. Twist the battery 2 or 3 times to twirl the battery plug wires. This helps hold the wire and battery in place when the battery is installed in the compartment. (C)
4. Install the battery into the compartment and press the wires securely into place.
5. Snap the battery compartment door back on and lock the end tab. (D)

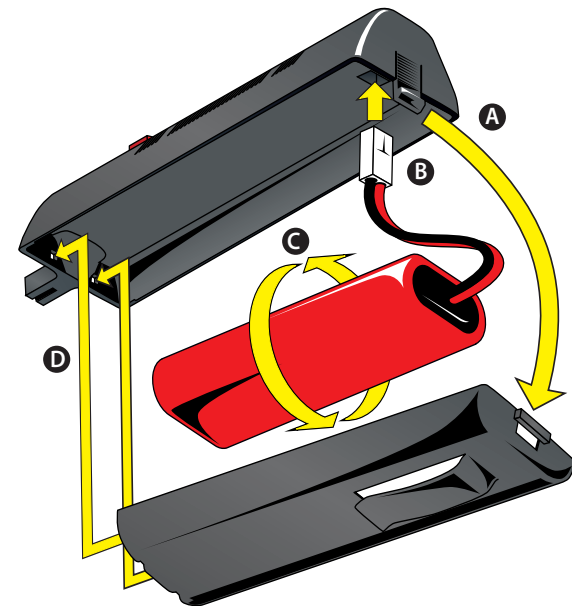

Using the EZ-Start

Your EZ-Start controller plugs into a 4-prong receptacle in the center of the bed on your T-Maxx 2.5R. When the red button on the controller is pressed, the EZ-Start motor begins to spin the engine and power from the control unit heats the glow plug. Assuming all settings and preparations are correct, the engine should start almost immediately.

Each of the two status indicator LEDs on the hand-held control unit, the **Motor** LED and the **Glow Plug** LED, should light green while starting. If either LED fails to light while starting, there is a fault indicated with that function:

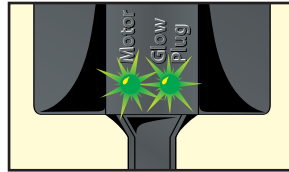

- ⦿ If the **Glow Plug** LED fails to light, the glow plug may be bad, or the glow plug wire may be damaged or disconnected.

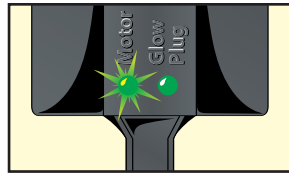

- ⦿ If the **Motor** LED fails to light and the starter fails to operate, then the EZ-Start is in protection mode.

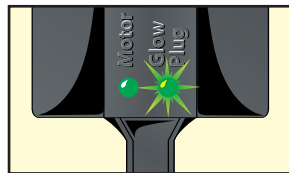

Protection Mode

The EZ-Start uses Smart Start™ technology to monitor the condition of the system and detect failures. The controller monitors the load being placed on the EZ-Start motor. If the load becomes excessive, the system shuts off power to the motor to prevent costly damage to the motor and the controller. This may occur, for example, if the engine floods with fuel during starting. The starter spins at first but when excessive fuel in the combustion chamber begins to lock up the engine, the starter motor slows under the heavier load. This causes the protection circuit to shut

off the power to the motor. Allow at least 3 minutes for the starter motor to cool and the circuit to automatically reset before continuing. Use the time to find and eliminate the condition that caused the excessive load on the starter motor.

Use a Strong Starter Battery

A weak starter battery, or one that has not been fully charged, may not deliver enough power to crank the engine over at the appropriate rpm to keep the piston from sticking at top dead center (TDC). A new engine will typically have a tight fit between the piston and the top of the sleeve. This is a tapered fit, and a tight piston sleeve fit on initial startup is desirable for those who want the best-performing engine. Make sure you are using a good quality battery pack that is fully charged (new batteries usually require several charge cycles to reach peak voltage and full capacity). This is especially important with a new engine that needs to be broken in. If the engine sticks at TDC, see page 43 for instructions on freeing the engine.

Shutting Off The Engine

Turning off the switch for the radio will not shut off the engine. To shut off the engine, use the shut-off clamp on the fuel line. Squeeze the clamp closed to shut off the fuel supply to the engine. Don't forget to release it when you restart the engine.

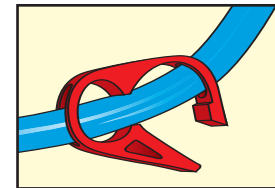

Avoid shutting off the engine by placing your finger over the exhaust outlet, especially if you are through driving for the day. This will leave more unburned fuel in the engine that could lead to harmful corrosion.

Always be careful not to touch the exhaust pipe after running, it can become very hot.



When the EZ-Start controller is in protection mode, wait at least three minutes before attempting to start the engine, to give the starter motor time to cool.



It's normal for your EZ-Start controller to become warm after repeated use.



See Important Points to Remember on page 4 for other precautions.



Never run your T-Maxx 2.5R indoors. Since the TRX 2.5R Racing Engine exhaust fumes are harmful, always run your model outdoors, in a well-ventilated area.



Your TRX 2.5R Racing Engine doesn't usually require priming. If you do need to prime your engine, watch the fuel line carefully to avoid flooding your engine. See page 44 for information on clearing a flooded engine.



Factory Needle Settings: Your carburetor is preset at the factory to give the correct air-to-fuel ratio and idle speed for engine break-in. Do not adjust the carburetor unless you observe a poor running condition that requires correction (see page 25 for stock settings).



Higher nitro requires a richer fuel mixture. When running 33% fuel, richen your high speed needle 3/4 turn if previously running 20% nitro and then re-tune the engine for maximum performance. See page 22 for more information.



BREAKING IN YOUR TRX 2.5R RACING ENGINE

The TRX 2.5R Racing Engine uses a ringless, aluminum-brass-chrome (ABC) piston/sleeve construction. This type of engine design relies on a very precise running fit between the piston and sleeve for cylinder sealing. **Engine break-in is necessary to allow the piston and sleeve to develop an extremely precise fit and optimum cylinder sealing. Therefore, proper engine break-in is critical to achieving the fastest, most reliable engine performance.**

Allow yourself about 1 to 1½ hours to complete the break-in procedure. The engine break-in period will take 5 tanks of fuel in a T-Maxx 2.5R. The break-in time is not the time to impress your friends with your new T-Maxx 2.5R. **You must wait until the engine is fully broken in before attempting sustained high speed running.** Patience and careful attention during break-in will reward you with the best-performing TRX 2.5R Racing Engine possible.

During break-in, your engine may appear to malfunction with symptoms like stalling, inconsistent performance, and fouled glow plugs. These are simply the normal "break-in pains" engines sometimes go through. They will disappear once your engine is fully broken in. Many owners report not experiencing any of these symptoms with TRX Racing Engines. **We recommend to go ahead and replace the glow plug with a new one after the engine break in procedure.**

Engine Break-in Procedure

The focus during break-in is to vary and limit the engine speed. This will be accomplished by accelerating and stopping at different rates for the first 5 tanks of fuel. As the engine begins to break-in, the duration and intensity of the acceleration will gradually increase. **Sustained high-speed running is not permitted until the 6th tank of fuel.** Perform the initial break-in on a large, flat, paved surface. **T-Maxx 2.5R is very fast and by tanks 4 and 5 you will need plenty of room for the truck to run in. Apply all throttle and braking actions gently. Abrupt acceleration or braking could cause the engine to stall unnecessarily.**

- Special break-in fuels are not recommended. Use the same fuel you plan to use everyday.
- If possible, avoid breaking-in the engine on extremely hot or cold days (see page 30).
- Pay careful attention to the fuel level. Do not allow the fuel tank to run completely empty. An extremely low fuel level causes the mixture to run too lean. This could result in a burned glow plug or extremely high engine temperatures.
- **Do not attempt to break in the TRX 2.5R Racing Engine by idling it on a stand. This will produce poor results.**

- Keep extra Traxxas glow plugs handy. The break-in process can cause deposits to form on the plug leading to plug failure.
- Change or clean your air filter after break-in.
- Follow the instructions exactly for each of the first 5 tanks of fuel.

Starting Your TRX 2.5R Racing Engine for the First Time

Before you start your TRX 2.5R Racing Engine for the first time, make sure you have read all instructions and precautions in this manual. **Pay close attention to the tank-by-tank break-in instructions in the next section, and make sure you have read and understood them before you run your engine.**

Your engine must be at room temperature (70°F or 21° C) or above the first time you start it. If it's cooler than room temperature outside, remove all fuel and keep your T-Maxx 2.5R indoors until you're ready to start it and then take it outside. If it's colder than 45 degrees, special considerations should be made. See cold weather break-in on page 30. We do not recommend running the model in temperatures below 35 degrees.

1. **Turn on the radio system** (see page 16).
2. Make sure the throttle trigger on the transmitter is in the idle (neutral) position.
3. Connect the EZ-Start controller according to the instructions on page 27.
4. Press the starter button in short two second bursts and watch for fuel moving through the fuel line up to the carburetor. Watch closely! The fuel moves very fast. If the fuel doesn't move through the line within 5 seconds, prime the engine by briefly (one or two seconds) covering the exhaust outlet with your finger until the fuel is just visible in the carburetor fuel line. **Watch carefully! If the engine is primed too long, it will flood with fuel and stop turning.**
5. Once fuel reaches the carburetor, the engine should quickly start and idle.
6. Disconnect the EZ-Start controller from the model.
7. Proceed with the engine break-in.
8. Do not rev your engine with no load (wheels off the ground).

If your engine doesn't start, refer to the troubleshooting tips beginning on page 43 or go online to www.traxxas.com/support. If your factory fuel mixture settings have been altered, refer to page 25. If you still have problems, contact Traxxas Customer Support at 1-888-TRAXXAS or support@traxxas.com.

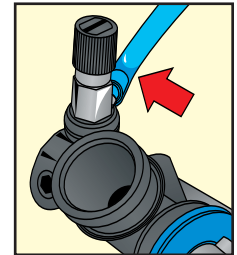

Tank 1

1. Drive the model with the **body off**.
2. Driving procedure: **Gently pull the throttle trigger to 1/4 throttle over a 2-second count. Then gently apply the brake to stop.** Count the two seconds out while accelerating: one thousand one, one thousand two, and then stop. Operate the throttle trigger as smoothly as you can. **Repeat this starting and stopping procedure until the first tank of fuel is nearly empty.**
3. Look for thick blue smoke exiting the exhaust outlet. If there is no smoke, richen the high-speed needle 1/4 turn, by turning the needle counterclockwise.
4. When the fuel tank is nearly empty, shut off the engine by pinching the fuel line connected to the carburetor (use the installed clamp).
5. Let the engine cool for 15 minutes.

Note: If at any point the engine cuts out or stalls during gentle acceleration, richen the high-speed needle 1/4 turn by turning the needle counterclockwise.

Tank 2

1. From tank 2 forward, T-Maxx 2.5R should be driven **with the body on**.
2. Driving procedure: **Gently pull the throttle trigger to 1/2 throttle over a 2-second count. Then gently apply the brake to stop.** Count the two seconds out while accelerating: one thousand one, one thousand two, and then stop. **Repeat this starting and stopping procedure until the second tank of fuel is nearly empty.**
3. When the fuel tank is nearly empty, shut off the engine and let it cool for 15 minutes.

Tank 3

1. Driving procedure: **Gently pull the throttle trigger to 1/2 throttle over a 3-second count. Then gently apply the brake to stop.** Count the three seconds out while accelerating: one thousand one, one thousand two, one thousand three, and then stop. **Repeat this starting and stopping procedure until the third tank of fuel is nearly empty.**

2. As the engine loosens, the idle speed may increase and cause the model to try to creep forward when stopped. Reduce the idle speed by turning the idle adjustment (see page 19) on the carburetor counterclockwise.
3. When the fuel tank is nearly empty, shut off the engine and refuel. From here on, you do not need to let the engine cool between tanks.

Tank 4

1. Driving procedure: **Gently pull the throttle trigger to full throttle over a 3-second count. Then gently apply the brake to stop.** Count the three seconds out while accelerating: one thousand one, one thousand two, one thousand three, and then stop. **Repeat this starting and stopping procedure until the fourth tank of fuel is nearly empty.**
2. Apply the throttle gradually! Your finger should not reach full throttle until the end of the three-second count. T-Maxx 2.5R may try to shift into second gear. If it does, reduce the throttle input. Do not let T-Maxx 2.5R shift out of first gear.
3. Keep your driving smooth and consistent.
4. When the fuel tank is nearly empty, shut off the engine and refuel.

Tank 5

1. Driving procedure: **Gently pull the throttle trigger to full throttle over a 3-second count, hold for 2 more seconds, and then gently apply the brake to stop.** Count the five seconds out while accelerating. **Repeat this starting and stopping procedure until the fifth tank of fuel is nearly empty.**
2. The model should now be shifting into second gear. If it is not, try turning the high-speed needle clockwise 1/8 turn to lean the fuel mixture slightly and test for shifting.
3. When the fuel tank is nearly empty, shut off the engine and refuel.

Tank 6

STOP! Clean your air filter before you proceed. Refer to the instructions on page 23. During the sixth tank of fuel, the engine can be tuned for general performance use. Proceed to the next section in this manual (page 31).

TANK	THROTTLE	TIME	COOL	BODY	NOTES
1	1/4	2 Seconds	15 Minutes	Off	Apply throttle gradually.
2	1/2	2 Seconds	15 Minutes	On	Apply throttle gradually.
3	1/2	3 Seconds	-	On	Reduce idle speed if necessary.
4	Full	3 Seconds	-	On	Do not allow shifting to high gear.
5	Full	5 Seconds	-	On	Accelerate over 3 second count, hold for 2 seconds.



High Altitude Operation: If you live in a high altitude region (5000 or more feet above sea level), the lower air density may require you to lean your high-speed fuel mixture slightly from the factory break in settings. Try this if you are experiencing difficult starting or extremely sluggish engine performance at high altitude.



As you gain experience in the hobby, you may discover that many people have differing opinions on what is the proper procedure to break-in a model engine. *Only use the Traxxas break-in procedure. Other break-in procedures could result in a weak, damaged, or otherwise poor performing engine.* The procedure outlined here was extensively tested and proven to yield better performing engines than other "common" break-in methods. Even if you have years of experience using model engines, please do not ignore this caution!

Winter Break-in Tips

During the break-in process, the piston and sleeve wear into each other to form a precise fit. The engine needs to heat up to a temperature around 200 to 215 degrees to allow the piston and sleeve to achieve this fit properly. A precise fit between these two components is critical for proper compression, and optimum performance. If the engine runs too cold during break-in, the piston and sleeve will not expand to their appropriate sizes for break-in, and this can lead to premature wear of these components. This wear may not become apparent until after winter has past, and the engine is operated under warmer running conditions.

- ☉ Warm the engine to approximately room temperature by removing all fuel and storing the vehicle inside at room temperature until just before starting the engine. An extremely cold engine can become difficult to start.
- ☉ After the engine is running, it is important to keep the temperature of the engine up around 200 to 215 degrees during break-in. In weather below 45 degrees, the TRX 2.5R Racing Engine will tend to run at lower temperatures between 160 to 180 degrees (when tuned at proper break-in mixture settings). This is too cool for break-in. **Do not lean the fuel mixture to increase engine temperature!** This will also decrease lubrication and cause your piston/sleeve to wear prematurely.
- ☉ Wrap the cooling head with a paper towel, clean rag or sock to help keep the engine running around the recommended 200 to 215 break-in temp. If too much heat is contained, the engine can actually run too hot. Make sure that you monitor the engine's temp closely for the first couple of tanks until you get the right amount of cover for the cooling head. This will, of course, depend on your current weather conditions. Adjusting the cover up and down, exposing more or fewer cooling fins, is a convenient way to regulate engine temps.
- ☉ For owners that do not have access to a temperature probe, a drop of water on the cooling head (around the glow plug area) should slowly sizzle for approximately 6 to 8 seconds around 200 to 210 degrees. If the water sizzles for only a few seconds, then it is likely that it is over 220 degrees, and needs to cool down. If the water takes a long time or does not evaporate at all, then the engine is too cool.
- ☉ We do not recommend that you operate your engine below 35 degrees Fahrenheit. If you insist on running your vehicle below 35 degrees, be aware that nitro engines may be very difficult to start and tune at extremely cold temperatures. Also, at temperatures below freezing, nitro fuel can actually begin to gel up, and this can be harmful to the engine.

Follow the remaining break-in procedures as outlined in this Owners Manual. This, along with the steps listed above, will ensure a good break-in for your new nitro engine, and provide many hours of enjoyment.

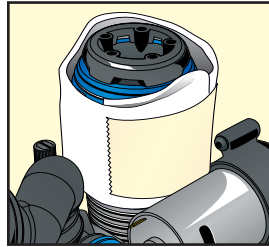

TUNING YOUR TRX 2.5R RACING ENGINE

The engine's performance depends on the fuel mixture. Turn the mixture needles clockwise to lean the fuel mixture and counterclockwise to richen it. Leaning the fuel mixture will increase engine power up to the engine's mechanical limits. **Never run the engine too lean (not enough fuel flow). Never lean the engine until it begins to cut-out or stall.** Leaning the engine beyond the safe allowable limits will result in poor performance and almost certain engine damage. Indications of an overly lean mixture include:

- ☉ **Cutting out or sudden loss of power during acceleration.**
- ☉ Overheating (temperature beyond 270° F at the glow plug).
- ☉ Little or no blue smoke coming from the exhaust.

If any of these conditions are present, stop immediately and richen the high speed mixture 1/4 turn. The engine will probably be slightly rich at that setting and you can then retune for performance. Always tune for performance by starting rich and moving leaner toward the ideal setting. Never try to tune from the lean side. There should always be a light stream of blue smoke coming from the exhaust.

Before you begin tuning, the engine should be warmed up to its normal operating temperature and running slightly rich. All final tuning adjustments must be made to the engine at its normal operating temperature. You can tell the engine is running rich by noting any of the following:

- ☉ Sluggish acceleration with blue smoke coming from the exhaust.
- ☉ T-Maxx 2.5R may not shift into second gear.
- ☉ There is unburned fuel spraying from the exhaust tip.
- ☉ Leaning the high-speed fuel mixture increases performance.

High-Speed Fuel Mixture Adjustment

With the engine warm and running at a rich setting, gradually lean the high-speed fuel mixture in 1/16 turn increments. Make several high-speed passes after each adjustment to clear out the engine and note any change in performance. The TRX 2.5R is extremely powerful. Remember to apply the throttle gradually to prevent wheelies or loss of control. Continue this procedure until there is no longer any performance improvement. **If any one of the following conditions occurs, the fuel mixture is already past the maximum safe lean setting:**

1. There is no longer any performance improvement.
2. The engine begins to cut out at high speed (**Danger!**).

3. There is a sudden loss of power during acceleration (**Danger!**).
4. The engine begins to overheat. Symptoms of overheating include:
 - ☉ Steam or smoke coming from the engine (not exhaust).
 - ☉ Hesitation or stalling during acceleration.
 - ☉ Popping or clattering sound when decelerating (detonation).
 - ☉ Fluctuating idle speed.
 - ☉ Temperature measurement above 270° F at the glow plug (A temperature reading above 270° alone does not necessarily indicate overheating. Look for other symptoms of overheating combined with temperature for a more accurate warning).

Richen the fuel mixture to the optimum setting by richening the high-speed needle at least 1/8 turn counterclockwise and retest. This setting will extend engine component life.

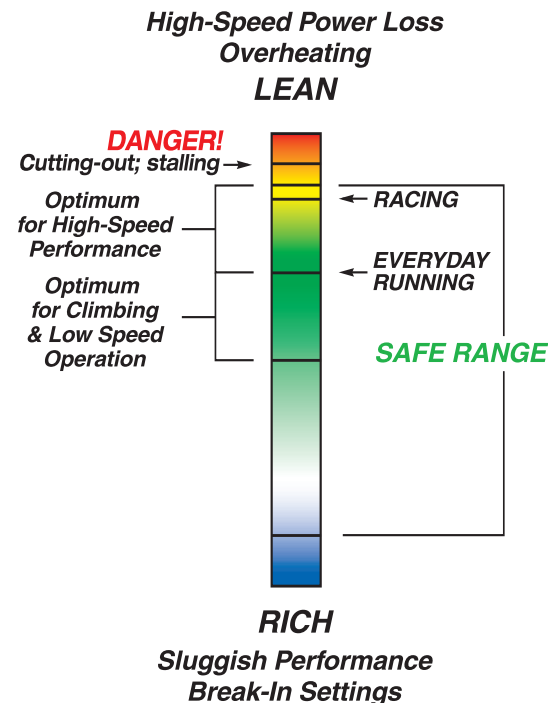

! When tuning for performance, watch closely to notice when there is no longer any increase in speed or power when the high-speed mixture is lean. If you lean the high-speed mixture to the point that the engine cuts-out, hesitates, or stalls, you are well into the danger zone and engine damage is likely. Richen the high-speed needle 1/4 turn and retune.

i For your convenience, the low-speed needle has a positive stop that prevents it from being over tightened and damaging the needle and seat. This also provides an easy way to gauge how many turns out from closed the low-speed needle adjustment is set to.



When adjusting the low speed fuel mixture, it is very important to make several high-speed runs with T-Maxx 2.5R between adjustments to clear out any excess fuel. Perform the pinch test immediately after. If the engine is allowed to idle for a long period of time, it could "load up" with fuel and give you an inaccurate measurement from your pinch test.



Higher nitro requires a richer fuel mixture. When running 33% fuel, richen your high speed needle 3/4 turn if previously running 20% nitro and then re-tune the engine for maximum performance. See page 22 for more information

Low-Speed Fuel Mixture Adjustment

The low-speed mixture is always set after the high-speed needle is correctly adjusted. The low-speed mixture is set using the pinch test.

1. Once the engine is warm, do several high-speed runs to confirm that the high-speed needle is set correctly.
2. Bring the vehicle in and pinch closed the fuel line going into the carburetor (use the engine shut-off clamp). The engine should run for 2-3 seconds, speed up, and then shut off.
3. If the engine runs longer than 3 seconds, then lean the low-speed needle 1/16 turn, make several more high-speed runs, and retest.
4. If the engine shuts off immediately without speeding up, then richen the low-speed needle 1/8 turn, make several more high-speed runs, and retest.

When the low-speed needle is set correctly, the engine's throttle response should be very quick, even to the point of making it difficult to keep T-Maxx 2.5R from doing a wheelie when you accelerate!

Idle Speed Adjustment

Once the high and low-speed mixtures have been set, reduce the idle speed to the minimum reliable idle speed. Remember, this adjustment should be made while the engine is running at normal operating temperature.

1. Turn the throttle trim on the transmitter so the brakes are applied (note its original position). This ensures that the throttle slide is resting against the idle adjustment screw.
2. Turn the screw counterclockwise to reduce the idle speed, or clockwise to increase it. The idle speed should be set as low as possible while still maintaining reliable running characteristics.
3. Reset the throttle trim on the transmitter to its original position.

Fuel Mixture Adjustment Chart

If the...	is..	then the air density is...	adjust (correct) the fuel mixture to be...
Humidity	Lower	Slightly more dense	Slightly richer
	Higher	Slightly less dense	Slightly leaner
Pressure (barometer)	Lower	Less dense	Leaner
	Higher	More dense	Richer
Temperature	Lower	More dense	Richer
	Higher	Less dense	Leaner
Altitude	Lower	More dense	Richer
	Higher	Less dense	Leaner
Nitro %	Lower		Leaner
	Higher		Richer

Fine-Tuning the Carburetor

After fine-tuning your TRX 2.5R Racing Engine at the end of the break-in procedure, no major adjustments to the fuel mixture are usually necessary. Make note of the temperature, humidity, and barometric pressure at the time you finished fine tuning your carburetor. Current weather conditions can be found online from national websites, local TV news websites, and television. This information will be considered your baseline setting.

You may need to adjust your carburetor needles to compensate for changes in temperature and barometric pressure (air density) from day to day. Generally, you'll need to richen the fuel mixture when the weather is colder than your baseline temperature and the air density is higher. Lean the fuel mixture when weather is warmer than your baseline temperature and the air density is lower. The chart below provides general guidelines on how weather conditions affect air density when they move higher or lower than your baseline setting (see page 24 for detailed info on how air density affects mixture settings).

Tuning the Engine by Temperature

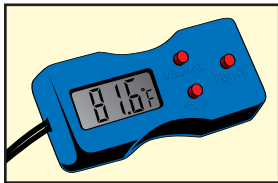

The following procedures require an optional infrared temperature probe or on-board temperature gauge (Traxxas on-board digital temperature gauge, part #4091). Engine temperature can be used as an effective tuning aid when you understand the relationship between

engine temperature and ambient temperature. The engine operating temperature, when tuned for maximum performance, will vary according to atmospheric conditions, engine load, gauge accuracy, and many other factors. The atmospheric condition that has the most influence on engine temperature is air temperature. Expect the engine temperature to vary almost in direct proportion to air temperature. Assuming you tuned the engine for the same maximum performance each day, the engine will run about twenty degrees hotter when it's ninety degrees outside than it would in seventy-degree weather. For this reason, we cannot give you a definitive temperature range that indicates the best possible engine tuning.

There is NO optimal temperature that can be used as a target to deliver the best engine tuning. Do not rely on a temp gauge alone to tune your engine. Tune the engine by paying very close attention to how it responds to changes in fuel mixture (more smoke/less smoke, fast/sluggish, reliable/stalling, smooth sound/ muffled sound, etc). Once the engine is tuned, then observe the temperature.

The temperature gauge can aid you in tuning by giving you a relative indication of how your adjustments are affecting the engine and to help prevent you from reaching excessive engine temperatures. For example, as you lean the fuel mixture, the engine performance will increase along with the temperature. If you continue to lean the fuel mixture and the temperature increases but the engine performance does not change, then you have exceeded the maximum safe lean setting. Make note of the engine temperature. Generally, try to keep your engine from exceeding 270°F when measured at the glow plug. If necessary, increase airflow to the engine by cutting out the rear of the body, windshield, and front valance. In some situations, the engine may perform very well with no stalling, lagging, or hesitation at temperatures above 270°F, particularly in very hot climates. If richening the fuel mixture to bring the temperature down to 270°F results in poor, sluggish performance (engine never cleans out) then return the engine back to a satisfactory state of tune based on how it sounds and performs (always with a visible stream of blue smoke coming from the exhaust). If engine temperature is exceeding 270°F with proper cooling and no signs of abnormal running, then avoid running the engine at its maximum lean setting. Watch closely for **any** signs of overheating. Richen the fuel mixture slightly to provide a safety margin of additional cooling lubrication. Symptoms of overheating include:

- ⊗ Steam or smoke coming from the engine (not exhaust).
- ⊗ Hesitation or stalling during acceleration.
- ⊗ Popping or clattering sound when decelerating (detonation).
- ⊗ Fluctuating idle speed.

DRIVING YOUR T-MAXX 2.5R

INTRODUCTION

Your TRX 2.5R Racing Engine is broken in, the fuel mixture is balanced, and the idle is set...now it's time to have some fun! This section contains instructions on making adjustments to your T-Maxx 2.5R. Before you go on, here are some important precautions to keep in mind.

- ☉ **Don't run your T-Maxx 2.5R in water, mud, snow, or wet grass.** It's tempting, but water and mud are easily drawn through the air filter and will severely damage the engine. Small amounts of moisture can cause electronics to fail and loss of control over your T-Maxx 2.5R. Snow is frozen water. Do not drive the T-Maxx 2.5R in snow or the electronics could be damaged by water.
- ☉ The TRX 2.5R Racing Engine is extremely powerful. Remember to apply the throttle gradually to prevent loss of control. T-Maxx 2.5R is very fast and responsive and is intended for experienced drivers. Do not drive over the limits of your reflexes and ability. Drive with caution at all times and gradually build up your ability to maintain control at T-Maxx 2.5R's upper performance limits.
- ☉ Don't hold T-Maxx 2.5R off the ground and rev the engine excessively with no load on the engine. This practice could result in internal engine damage. Avoid over revving the engine when T-Maxx 2.5R is airborne after a jump.
- ☉ Avoid excessive high-speed running for extended periods of time or over long distances. This could cause the engine to build up enough speed to exceed maximum safe rpm limits.
- ☉ Don't drive your T-Maxx 2.5R with drive train damage of any kind. The engine could be damaged due to overloads caused by drivetrain friction, or over-revving caused by loose or missing parts.
- ☉ Don't tow anything with your T-Maxx 2.5R. The engine is cooled by airflow created by speed. Towing creates a high load on the engine, and at the same time limits cooling of the engine due to low vehicle speed.
- ☉ If your T-Maxx 2.5R gets stuck, stop driving immediately. Move the vehicle and then continue driving.
- ☉ Never turn off the radio system while the engine is running. The truck could run out of control.

Forward and Reverse Operation

Forward and reverse gears are selected with the shift button located in the transmitter handle grip. The switch is normally in the down, or forward, position.

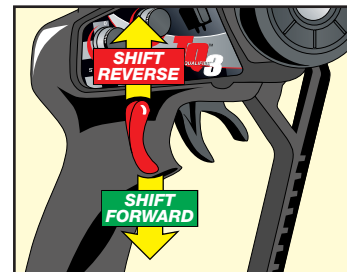

- ☉ To shift into reverse, bring your T-Maxx 2.5R to a **complete stop** and push the shift button up. Accelerate to engage the gear.
- ☉ To return to forward gear, repeat the same procedure but move the shift button down.
- ☉ T-Maxx 2.5R will not shift between forward and reverse unless the truck is stopped. If it will not shift, then refer to the troubleshooting section on www.Traxxas.com or call Traxxas support.

Driving Tips

- ☉ Monster trucks by design have a high center of gravity that requires a different driving technique. To prevent rollovers, slow down as you approach turns and then apply moderate throttle through the turns. This technique will help T-Maxx 2.5R grab the surface and turn sharper.
- ☉ Do not apply brakes and turn the wheel at the same time. You could tip the truck over.
- ☉ When jumping, apply some throttle while T-Maxx 2.5R is in the air to keep the truck's nose up and land level on all 4 wheels. Be careful not to over-rev the engine or land at full throttle. Either could seriously damage your T-Maxx 2.5R. If the nose of the truck is too high, then quickly tap the brake to level the truck in the air.
- ☉ Drive over large obstacles (such as curbs and rocks) at an angle, instead of head on. This will allow the suspension to articulate and absorb the impact much easier.
- ☉ Even though T-Maxx 2.5R is capable of high speed in reverse, it is very difficult to control while driving in reverse. Limit your reverse speed to prevent crashing or flipping your T-Maxx 2.5R.
- ☉ Change or clean your air filter element after each hour of running. This is critical for the life of your engine. Running time includes the engine break-in period.

TUNING ADJUSTMENTS

SUSPENSION TUNING

Adjusting the Pivot Ball Caps

The pivot ball caps should be adjusted so that the pivot balls operate freely in the axle carriers with no excess play. Use the provided four-way suspension multi-tool to tighten or loosen the pivot ball cap.



Caster Adjustment

The T-Maxx 2.5R offers the ability to adjust the caster angle of the front suspension. Caster adjustment may be used to influence the understeer/oversteer handling characteristics of the T-Maxx 2.5R. Increasing the caster angle will increase the tendency of the truck to oversteer (less traction on the rear tires, more traction on the front tires), while decreasing the caster angle will cause the truck to have a tendency to understeer (push in the turns). This effect becomes more pronounced at higher steering angles and higher spring rates. Caster is adjusted by repositioning the shims on the pivot point of the upper suspension arms.

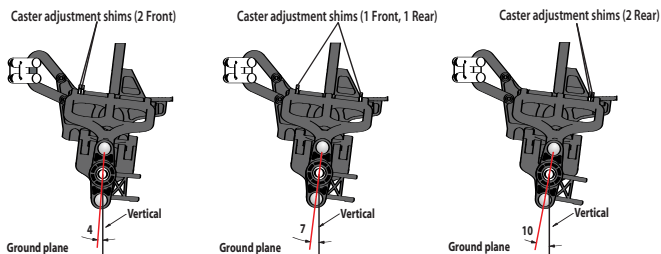

The stock caster setting is 7-degrees with one shim at each end of the arm. Reduce the caster angle to 4-degrees by removing the rear shim and inserting it next to the front shim. The caster angle can be increased to 10-degrees by removing the front shim and inserting it next to the rear shim.

Fine Tuning the Shocks

The eight shocks (oil dampers) on your T-Maxx 2.5R have tremendous influence on its handling. Whenever you rebuild your shocks, or make any changes to the pistons, springs or oil, always do it carefully and in sets (front or rear). Piston head selection depends on the range of oil viscosities that you have available. For example, using a two-hole piston with lightweight oil will give you the same damping as a three-hole piston with heavier oil.

We recommend using two-hole pistons with a range of oil viscosities from 10W to 40W (available from your hobby shop). The thinner viscosity oils (30W or less) flow with less resistance and provide less damping, while thicker oils provide more dampening. Use only 100% pure silicone shock oil to prolong seal life. From the factory, the T-Maxx 2.5R uses 30W oil.

The ride height for the T-Maxx 2.5R can be adjusted by adding or removing the clip-on spring pre-load spacers. Note that changes in ride height will occur when changes in shock angle or spring rates are made. You can compensate for ride height changes by changing the pre-load spacers on the shocks

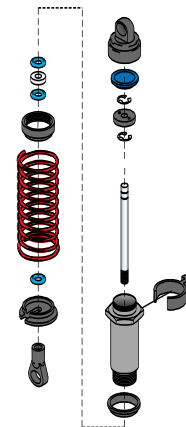

Shock Mounting Positions

Big bumps and rough terrain require a softer suspension with the maximum possible suspension travel and ride height. Racing on a prepared track or on-road use requires a lower ride height and firmer, more progressive suspension settings. The more progressive suspension settings help reduce body roll (increased roll stiffness), dive during braking, and squat during acceleration.

Upper shock mounting position (A) should generally be used with lower shock mounting positions 1 and 2. Upper shock mounting position (B) should be generally be used with lower shock mounting positions 3 and 4. The innermost upper shock mounting position (0) can be used for tuning with the inner pair of lower shock mounting positions on the arm (1,2). It is not compatible with lower shock mounting positions 3 and 4. Other combinations may be used to achieve individualized suspension settings.

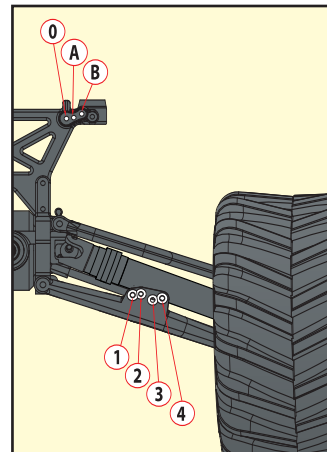

i For easier access to the rear-most shock mounting screw, remove the one end of the rear turnbuckle. In the front, remove the suspension pin from the lower front suspension arm to gain easier access to the lower shock mounting screws.

Lower Shock Mounting Positions

In the out-of-the-box configuration, the shocks are installed in position (A) on the shock tower and position (2) on the lower suspension arm. This setting allows for firm suspension and low ride height, increasing the spring force (at the wheel). This setting improves high-speed cornering on smoother terrain by lowering the center of gravity. Body roll, brake dive, and squat are also reduced.

The inner pair of holes on the lower suspension arm should be used to increase the ride height of the T-Maxx 2.5R. The more vertical position of the shocks will allow for lower shock progression and the soft, plush feel that's characteristic of a Traxxas Maxx Truck.

Spring rate (at the wheel) increases as the lower shock mounting position is moved from position (1) to position (4). This is equivalent to using stiffer springs. Use higher spring rate settings for flatter terrain with smaller and fewer bumps, and lower spring rate settings for bigger bumps.

Ride height decreases as the lower shock mounting position is moved from position (1) to position (4). Each pair of lower shock mounting holes

(1,2 and 3,4) has equal ride height. Use lower ride height for high-speed cornering and flat terrain, and when racing on relatively smooth tracks. Increase the ride height for rougher terrain and tracks.

Upper Shock Mounting Positions

The upper shock mounting positions will have suspension effects opposite from the lower shock mounting positions.

Spring rate (at the wheel), increases as the upper shock mounting position is moved from position (A) to position (B).

Ride height is not affected by changes in the upper shock mounting position.

Use the chart below to see the effect of the various shock mounting positions. The horizontal length of the lines indicates the amount of suspension travel. The angle or slope of the lines indicates the spring rate (at the wheel).

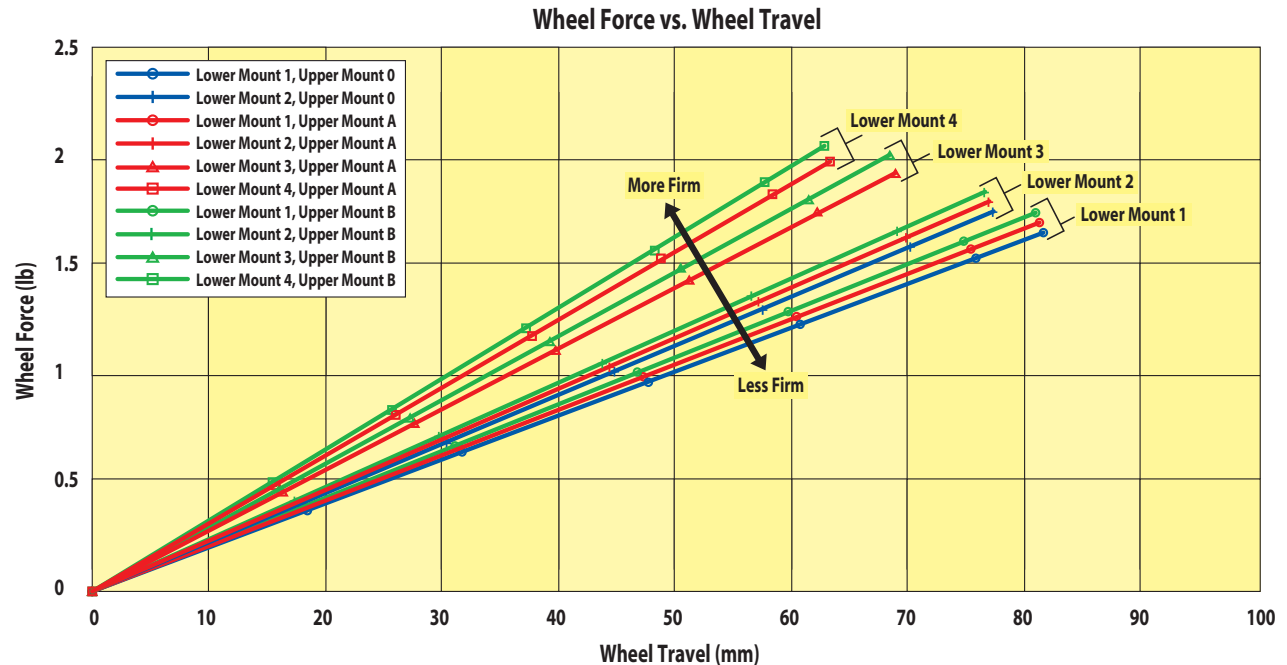

ALIGNMENT SETTINGS

Adjusting the Toe-in

Your T-Maxx 2.5R comes from the factory with zero degrees of toe-in in the front, and one degree of toe-in in the rear. You can adjust the toe-in on the front and rear of the truck. Set the steering trim on your transmitter to neutral. Next, adjust your steering turnbuckles so that both front wheels are pointing straight ahead and are parallel to each other (0 degrees toe-in). This will ensure the same amount of steering in both directions. Adjust the rear toe control links so that the rear wheels have 1° of toe-in.

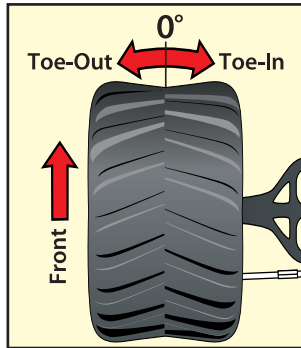

Static Camber Adjustment

The wheels can be set to have either positive or negative camber (see illustration below). The camber angle changes as the wheel moves up and down through its range of travel. Static camber is the camber angle at the wheel when the vehicle is set at its normal, stationary ride height.



The suspension pivot balls located in the axle carriers adjust the static camber. The pivot balls are protected by blue dust plugs. To adjust your static camber, insert the supplied 2.5mm hex wrench through the slit in the dust plug and engage the end of the pivot ball (compressing the suspension until the arms are parallel to the ground will allow for easier hex wrench engagement). The upper pivot ball is normally screwed all the way in. Negative camber is achieved by screwing the pivot ball of the lower control arm out. **Note:** When camber is changed, the toe angle of the wheel has to be reset.

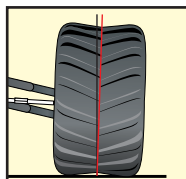

Positive Camber

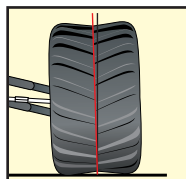

Negative Camber

Static Camber Base Factory Settings

Front: 1-degree negative camber each side

Rear: 1-degree negative camber each side

TRANSMISSION TUNING

Adjusting the Slipper Clutch

Your T-Maxx 2.5R is equipped with an adjustable Torque Control slipper clutch. The slipper clutch is integrated into the main spur gear on the transmission (see page 6). The slipper clutch is adjusted using the spring-loaded locknut on the slipper shaft. Use the supplied 8mm open-end metric wrench. To tighten or loosen the slipper nut, insert the 2.0mm hex wrench into the hole in the end of the slipper shaft. This locks the shaft for adjustments. Turn the adjustment nut clockwise to tighten (less slippage) and counter-clockwise to loosen (more slippage). The slipper clutch has two functions:

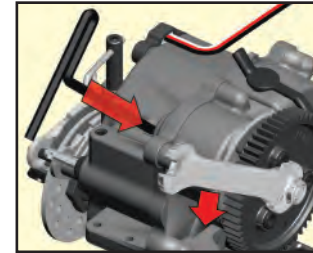

1. Limiting the engine's torque output to the wheels to prevent wheelspin on low traction surfaces and help to prevent damage to the gears in the transmission during on-throttle landings.
2. Protecting the drivetrain from sudden impact or shock loads (such as landing from a jump with the engine at full throttle).

From the factory the slipper clutch is set for minimal slippage, just enough to protect the drivetrain from shock loads. On slippery, low traction surfaces such as a hard-packed, dry racetrack you may benefit from loosening the slipper adjustment nut to allow for more clutch slippage. This will make the truck easier and more forgiving to drive by helping to reduce the amount of wheel spin. Loosening the slipper adjustment can also improve performance on extreme high traction surfaces by preventing the front end from lifting off of the ground when accelerating. Make slipper adjustments in small 1/8 turn increments.

The maximum tight setting for the slipper is just at the point where there is little or no tire slippage on a high traction surface such as concrete or a prepared racetrack. The slipper should not be tightened to the point that clutch slippage is completely eliminated. Do not overtighten the slipper nut or you could damage the slipper bearings, pressure plates, or other components.



All of the toe links are installed on the truck so that the left hand thread indicators point to the same direction. This makes it easier to remember which way to turn the wrench to increase or decrease toe link length (the direction is same at all four corners). Note that the groove in the hex indicates the side of the toe link with the left-hand threads.

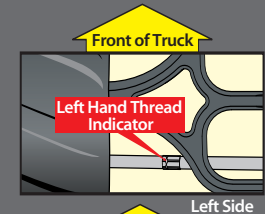

Left Side

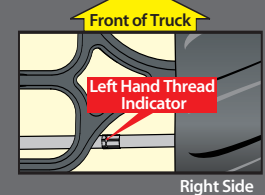

Right Side

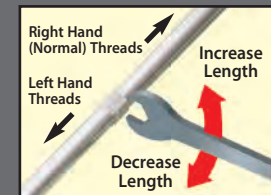



Two Speed Adjustment note: If the truck will not roll forward while the spur gear is held, the transmission may still be in reverse gear.

Adjusting the Two-Speed Transmission

T-Maxx 2.5R comes equipped with an adjustable two-speed transmission. When the shift point on the transmission is adjusted correctly, it will maximize acceleration and improve drivability. Use a 2mm hex wrench to adjust the shift point. To make the adjustment, the engine must be off (not running).

1. Shift the transmission into forward gear (shift button down).
2. Remove the rubber access plug from the top of the transmission housing.
3. While looking through the opening, rotate the spur gear to align the cutout (notch) on the internal 2-speed clutch drum with the opening.
4. Hold the spur gear and slowly roll the truck forward until the hex on the black adjustment set screw becomes visible in the opening. **Note:** the truck will only roll forward (not backwards) when the spur gear is held stationary.
5. Insert the 2.0mm hex wrench through the clutch drum and into the adjustment screw.
6. Turn the adjustment screw 1/8 turn counter clockwise to lower the shift point (shifts sooner). Be careful not to loosen the adjustment screw too much or you may cause the screw and spring to fall out (requiring major disassembly and repair). Turn the adjustment screw clockwise for later shifts.
7. Reinstall the rubber access plug to prevent dirt from entering the transmission. Do not put oil or other lubricants into the transmission through the two-speed adjustment access.
8. Check performance by running a test lap after each adjustment. On a small race track with many tight turns, try setting the shift point later so that the truck only shifts into second gear on the main straightaway. This will prevent an unexpected shift in the middle of a turn. On larger tracks it may be necessary to allow earlier shifts for increased speed.

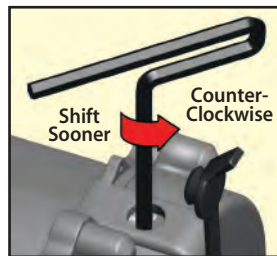
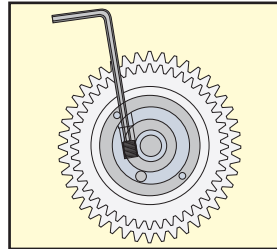
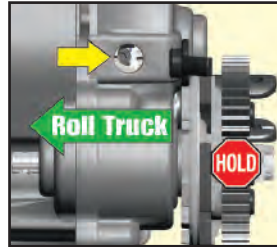

Adjusting the Spur Gear/Clutch Bell Gear Mesh

The ideal spur gear/clutch bell gear mesh for T-Maxx 2.5R is 0.1mm. To set the gear mesh, place a strip of standard letter/A4 size copy or printer paper (about 0.1mm thick) between the mating teeth. Loosen the four engine mount screws from the bottom side of the chassis (see image) and slide the engine mount up to push the clutch bell gear against the spur gear so the paper is not too tight to pull out or too loose that it will fall out. Tighten the engine mount screws securely. When the paper is removed, you should feel only the slightest amount of play between the gears (almost none) and there should be no binding or friction.

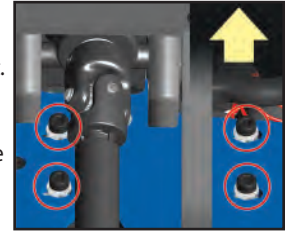

Changing the Spur Gear

1. Remove the four cap head screws that secure the engine to the engine mount.
2. Remove the button head screw that secures the pipe hanger to the rear body mount (see inset).
3. Carefully remove the engine and exhaust system from the spur gear area to allow enough room to remove the spur gear.
4. Remove the three screws on the slipper clutch assembly using a 2.5mm hex wrench. Slide the spur gear off of the slipper shaft. If the spur gear is too tight on the shaft, gently pry on the back of the gear with a flat screw driver to loosen it.



Repeat the above steps in reverse order to install the new spur gear

Adjusting the Gear Ratio

The gear ratio on T-Maxx 2.5R can be adjusted for different conditions that may require either increased acceleration or increased top speed. Adjusting the gear ratio is accomplished by changing the clutch bell on the engine and/or the spur gear (slipper clutch gear) on the transmission. From the factory, T-Maxx 2.5R is equipped with a 20-tooth clutch bell and a 54-tooth spur gear. This combination will provide a good balance of acceleration and top speed. Optional spur gears and clutch bell gears are listed on your parts list. Refer to the chart on page 39 for possible gearing combinations.

Adjusting the Two-Speed Ratios

T-Maxx 2.5R is equipped to allow adjustment to the 2-speed by installing optional close and wide-ratio gearsets. This requires transmission removal and disassembly (see www.Traxxas.com for detailed instructions). The close ratio gearsets will reduce top speed slightly but will provide more powerful acceleration by reducing engine rpm loss when shifting from 1st gear to 2nd gear. The wide ratio gear set is designed for wide open areas and will increase top speed, but reduce acceleration due to greater rpm loss when shifting gears.

The following gear ratio chart shows the available combinations with optional spur gears, clutch bells, and two-speed gear sets.

With 20T Clutch Bell (Standard)		# of Spur Gear Teeth		
2nd gear sets	Gear	54	56	58
17T/39T (Standard)	1st	25.42	26.36	27.30
	2nd	17.63	18.28	18.94
16T/40T (Close)	1st	25.42	26.36	27.30
	2nd	19.21	19.92	20.63
18T/38T (Wide)	1st	25.42*	26.36	27.30
	2nd	16.22*	16.82	17.42

With 22T Clutch Bell		# of Spur Gear Teeth		
2nd gear sets	Gear	54	56	58
17T/39T (Standard)	1st	23.11	23.96	24.82
	2nd	16.03	16.62	17.21
16T/40T (Close)	1st	23.11	23.96	24.82
	2nd	17.47	18.11	18.76
18T/38T (Wide)	1st	23.11	23.96	24.82
	2nd	14.75	15.29	15.84

With 24T Clutch Bell		# of Spur Gear Teeth		
2nd gear sets	Gear	54	56	58
17T/39T (Standard)	1st	21.18	21.97	22.75
	2nd	14.69	15.24	15.78
16T/40T (Close)	1st	21.18	21.97	22.75
	2nd	16.01	16.60	17.20
18T/38T (Wide)	1st	21.18	21.97	22.75
	2nd	13.52	14.02	14.52

*stock configuration out of the box

BRAKE SETUP & ADJUSTMENT

T-Maxx 2.5R is equipped with a disc brake that rides on the yoke of the transmission's front output shaft. The brake is preset at the factory and should not require attention. As the brake material wears, future adjustments may be necessary.

Brake Shoulder Screw Adjustment

The two shoulder bolts that are used to secure the brake pads to the transmission housing may need to be adjusted periodically as the brake material wears down. They should be tightened so a 0.50mm (.020") gap exists between the disc and the brake pad (on the transmission side). Adjust in one of the following ways:

1. Use a .50mm feeler gauge between the brake pad insert and brake disc.



2. Push the outer brake pad firmly against the inner pad with your finger, sandwiching the brake disc between the brake calipers. Tighten the brake shoulder bolts until they just barely touch the brake pads. Do not over tighten these fasteners or you could damage the brake calipers. Loosen each of the shoulder bolts by 1 turn.

Brake Pad Wear and Replacement

During normal use the brake pads should wear at a relatively slow rate. However, if the brake pads wear down close to the metal pad holders, they should be replaced. Any more wear than this could cause damage to the brake parts and improper operation of the brake system.



If the engine is worn or damaged enough to require replacing the piston, sleeve, or connecting rod, consider exchanging your old engine for a brand new engine under the terms of the Traxxas Lifetime Engine Replacement Plan (ERP). It could save you time and effort. Details are in your model's documentation package.



The TRX 2.5R Racing Engine is designed to be easy to rebuild. Critical engine components such as the crankcase, crankshaft, and engine bearings are made to extremely high quality standards and should under normal circumstances outlast multiple sets of pistons, sleeves, connecting rods, and wrist pins (reciprocating assemblies). It could be more economical for you to continue to use your good bearings and crankshafts, and simply replace the reciprocating assembly as needed. Engine assembly is not difficult and replacing the reciprocating assembly does not require any special tools or skills.

Your T-Maxx 2.5R requires timely maintenance in order to stay in top running condition. **Neglecting the maintenance could allow dirt, deposits, and moisture to build up inside the engine leading to internal engine failure.** The following procedures should be taken very seriously.

After each hour of running:

- ⦿ Clean and re-oil the air filter. The instructions for this procedure are on page 23. **We cannot stress enough the value of cleaning your air filter at the scheduled intervals.** The cleanliness and condition of your air filter directly influences the running life span of your engine. **Do not skip air filter maintenance!**
- ⦿ Clean the outside of the engine of accumulated dirt, oil, and grime. Accumulated grime will decrease the engine's ability to cool itself.
- ⦿ Tighten the wheel nuts (especially on the left side). Use the 8mm end of the included glow plug wrench.

After each running session:

- ⦿ Perform after-run maintenance on the engine. This clears the engine of destructive moisture and other corrosive deposits. **This is extremely important for the life of the engine.** See page 41 for after-run maintenance procedures.
- ⦿ Inspect the gears for wear, broken teeth, or debris lodged between the teeth
- ⦿ Inspect the vehicle for obvious damage or wear. Look for:
 1. Loose or missing screws
 2. Cracked, bent, or damaged parts
 3. Cut or loose wiring
 4. Cut or kinked fuel lines
 5. Signs of fuel leakage

Other periodic maintenance:

- ⦿ **Connecting rod:** The connecting rod should be replaced when the piston and sleeve are replaced. Also replace the piston wrist pin and G-clip whenever the connecting rod is replaced. As with other internal engine components, connecting rod life depends engine's usage and the quality and frequency of the engine maintenance. Inspect the connecting rod after 3-gallons of fuel have been used.



- ⦿ **Slipper clutch pads** (friction material): Under normal use, the friction material in the slipper clutch should wear very slowly. If the thickness of any one of the slipper clutch pads is 1.8mm or less, the friction disc should be replaced. Measure the pad thickness using calipers or measuring against the diameter of the 1.5 and 2.0mm hex wrenches provided with the model.

- ⦿ **Piston/sleeve:** The life of the piston and sleeve will vary greatly with how the engine was used and maintained. The piston and sleeve should be replaced when they no longer seal effectively (loss of compression). Symptoms include the engine being difficult to start when warm, stalling when warm, and stalling when throttle is suddenly closed to idle. Replace the wrist pin and G-clip whenever the piston and sleeve are replaced.

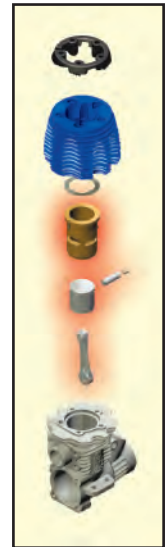

After-run Procedure

You must perform after-run maintenance on your TRX 2.5R Racing Engine whenever the model will be stored for longer than a few hours. Taking the time to prepare your engine for storage will reward you with longer engine life, easier starting, and better performance.

When a nitro engine is shut off, some excess unburned fuel remains in the engine. The methanol in model engine fuel is hygroscopic, which means it easily attracts and absorbs moisture. This moisture can cause rust and corrosion on the steel engine parts (crankshaft, bearings, wrist pin and starter shaft) if the fuel is not removed from the engine. There are after-run oil products available from your hobby dealer or you can use WD-40™, a common household lubricant. To ensure your TRX 2.5R Racing Engine is protected from internal corrosion, use the following procedure:

1. Shut off the engine by pinching the fuel line closed. This allows most of the excess fuel to be consumed by the engine. Be sure the throttle is in the idle position. You may have to pinch the fuel line closed for several seconds before the engine stops.
2. Completely empty the fuel tank. Use your fuel-dispensing bottle to suck out the old fuel. Do not mix the old fuel with your fresh fuel supply. If you leave fuel in the tank, transporting or handling your T-Maxx 2.5R may cause fuel to run into the engine.
3. With the fuel tank empty and the throttle at the idle position, try to start the engine. The engine will most likely start and run for a few seconds as it uses up any fuel remaining in the engine and fuel lines.
4. Once the engine stops, clean the outside of the engine with compressed air or spray motor cleaner. Once the engine is clean and dry, remove the glow plug power wire, glow plug, and air filter.
5. Open the throttle fully and spray a one-second burst of WD-40 into the carburetor and into the glow plug hole (Caution! Wear safety glasses to prevent spray from getting into your eyes). If you are using after-run oil, follow the manufacturer's instructions.
6. Place a rag or paper towel over the engine to catch any WD-40 or after-run oil that may come out the carburetor or glow plug hole.
7. Connect the EZ-Start controller to the model and spin the engine for 10 seconds.
8. Remove the rag or paper towel and repeat steps 5–7 two more times.
9. Clean and re-oil the air filter so it will be ready for use next time. See page 23 for air filter maintenance instructions.
10. Replace the glow plug, reconnect the glow plug power wire, and reinstall the air filter.



Denatured alcohol (available from home centers and paint supply stores) in a spray bottle is an extremely effective cleaner. Be sure to wear safety glasses and gloves when working with denatured alcohol.



Be sure to follow proper maintenance and storage procedures to avoid damage to your engine and other components of your T-Maxx 2.5R.



Don't put the fuel from your tank back into your fuel jug. Dispose of it properly, following city or county regulations.



Always wear eye protection when using compressed air or spray cleaners and lubricants.

The following section addresses some very basic engine and radio questions you may have about your T-Maxx 2.5R. Most questions arise from simple user errors or minor adjustments that are easy to correct. If you can't find a solution for your T-Maxx 2.5R here, then visit our Web site at www.Traxxas.com/support. There you will find a much more extensive and detailed online troubleshooting area. In addition, you may call Traxxas Customer Service at 1-888-TRAXXAS (outside the U.S. call 972-265-8000).

Radio system does not work properly:

- ☉ If the power light on the transmitter does not come on, check for proper battery installation and that the batteries are new and/or fully charged. If the power light is blinking, then the transmitter batteries are weak and should be replaced. See page 11 for more details.
- ☉ If the transmitter light is on but the radio is still not responding, check for proper installation of the receiver batteries and that the batteries are new and/or fully charged. Check to make sure the on/off switch on the model is in the on position. Finally, if there is still no response check the red and black wires that connect the battery pack to the "batt" terminal on the receiver (you will have to remove the receiver cover). Make sure the wires are not pinched or damaged and that the plug is secure in the receiver. See page 12 for more details.

Short radio range:

- ☉ If the radio range appears short, then first check to make sure the transmitter antenna is fully extended and that the antenna in the T-Maxx 2.5R is in place and has not been cut or damaged. Next, make sure the batteries are all fresh or fully charged. Finally, if you are still experiencing short range, try a different location. Sometimes there can be interference from various sources that can cause your radio to malfunction.

Engine will not spin (EZ-Start will not turn the engine):

- ☉ If neither LED on the controller lights, the EZ-Start battery could be discharged or improperly connected. Inspect and recharge if necessary.
- ☉ If the glow plug LED lights and the motor LED does not, then the EZ-Start controller is in protection mode. Allow the controller to cool for at least three minutes. The circuitry should automatically reset.
- ☉ Check to make sure the wires are connected to the EZ-Start motor in the T-Maxx 2.5R. The red wire should connect to the positive motor terminal, indicated by a red dot next to the terminal.
- ☉ The engine could be flooded. If too much fuel accumulates in the combustion chamber at start up, the engine will hydraulically lock. Follow the procedure on page 44 for clearing a flooded engine.

- ☉ Check for binding at the engine flywheel. If you are not able to turn the engine by hand, the engine could be flooded, there could be binding in the clutch system, or there could be internal engine damage. (Note: It is normal for the engine to be extremely tight and hard to turn when the piston reaches the top of the compression stroke.)

Engine extremely sluggish, hard to start, and will not idle during tank 1 of the break in:

- ☉ It is possible that the factory adjusted break-in settings on your carburetor are too rich for your geographic location, atmospheric conditions, or fuel brand. Extremes in temperature, humidity, barometric pressure, and altitude can't always be accounted for with a single high-speed needle setting. The symptoms described above can occur when the air density is very low such as in high mountainous elevations, and extremely cold temperatures. Under these conditions, lean the fuel mixture slightly, 1/8 turn, to see if there is any improvement in starting and idling. Only lean the fuel mixture just until the engine will run and idle reliably and then proceed with the break in.
- ☉ The contents of different brands of fuel (other than Traxxas Top Fuel) in combination with extreme atmospheric conditions can also make the factory preset break-in settings too rich and cause the symptoms described above. Again, try leaning the fuel mixture slightly, 1/8 turn, to see if there is any improvement in starting and idling.

Engine spins but will not start:

- ☉ If the engine is spinning but will not start, first check to make sure that both the motor and glow plug LEDs on the EZ-Start controller light when the button is depressed. If the glow plug LED does not light, make sure the blue glow plug wire is tightly connected and is not damaged in any way. If the wire is good, then replace the glow plug. It is normal for glow plugs to require periodic replacement. Only use Traxxas heavy-duty long glow plugs (see your parts list).
- ☉ Check to make sure the fuel is getting to the carburetor. Remove the fuel line where it connects to the carburetor to see if there is fuel in it. If not, you may need to prime the engine. Reconnect the fuel line and then refer to page 28 for instructions on priming the engine.
- ☉ Check your fuel mixture settings. It may be necessary to adjust the fuel mixture if the outside temperature or barometric pressure has changed significantly since the last time the engine was run (see Fine Tuning the Carburetor on page 33). Turn the high-speed needle out (rich/counterclockwise) 1/4 turn, hold the throttle trigger at about 1/2 throttle and try again to start the engine. Once started, retune the engine for performance (see page 31).

- ⊗ The engine could be worn. If the fit between the piston and sleeve is loose, compression is reduced and the engine will be difficult to start when it is warm, and may tend to stall when running and when the throttle is closed suddenly to idle. Engine life depends on many factors including fuel type, air filter maintenance, needle settings, and how the engine was used. For example, if the engine was allowed to ingest dirt from lack of air filter maintenance or running through water, then the internal engine components could wear out extremely fast.
- ⊗ Glow plug may have failed. If using an EZ-Start, check to see if the glow plug light is on during starting. If not, replace the glow plug. If using a glow ignitor, remove and check the glow plug.

Engine performance sluggish:

- ⊗ Engine performance depends mostly on the fuel mixture settings and how they compensate for the current atmospheric conditions. Before you suspect other failures with the engine, richen the high-speed needle at least 1/4 turn and then retune the engine for performance (see page 31).
- ⊗ If the fuel mixture seems to be set correctly, make sure the fuel is fresh. If the fuel is old, or was left uncapped for a long period, then some of the important fuel components could have evaporated. Try new, fresh, Traxxas Top Fuel.
- ⊗ Try a new Traxxas glow plug. Sometimes a glow plug will work well enough to start the engine but not be able to deliver the engine's full performance potential.
- ⊗ Check to make sure there is no binding in the driveline that would cause excessive loads on the engine.

Clearing a Flooded Engine

If the engine is primed for too long during startup, then it can become flooded with fuel. When the engine is flooded it will no longer turn due to excess fuel in the combustion chamber preventing upward movement of the piston. Use the following procedure to clear a flooded engine:

1. Remove the blue glow plug wire.
2. Remove the glow plug and gasket with the glow plug wrench supplied with your model. A 5/16 or 8mm nut driver will also work.
3. Turn the model upside down and plug in the EZ-Start controller.

4. Push the EZ-Start button for several seconds to clear the engine of excess fuel. Do not look into the glow plug hole while the engine is spinning or you could spray fuel into your face!
5. Turn the model over and reinstall the glow plug and gasket.
6. Reconnect the blue glow plug wire to the glow plug.
7. Reconnect the EZ-Start controller.
8. Do not prime the engine. Pull the throttle to 1/2 throttle and push the EZ-Start button. The engine should start immediately.

Piston stuck at "top dead center" (TDC)

"Top dead center" is the position where the piston is at the very top of the tapered sleeve. Occasionally an engine can get "stuck" at this position. This is most likely to happen on new engines during break-in, but can also happen at other times. If the engine is stuck at TDC, use the following procedure to release the piston from the sleeve:

1. Remove the glow plug using the included tool or 8mm (5/16") nut driver and verify that the piston is at the top of its stroke.
2. Use a flat blade screwdriver to rotate the flywheel. Place the blade of the driver into one of the grooves of the flywheel and push down, turning the flywheel counter-clockwise when viewed from the front. The flywheel should turn, unsticking the piston from the sleeve.
3. Put two or three drops of light machine oil into the glow plug hole to lubricate the piston and sleeve. Do not use too much oil. It will hydro-lock the engine. Verify the starter will spin the engine with the glow plug out.
4. Rotate the flywheel so the piston is at bottom dead center and replace the glow plug with gasket. Reconnect the blue glow plug wire.
5. You should now be able to start the engine with the EZ-Start.

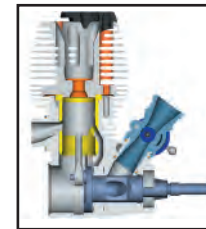

Top Dead Center

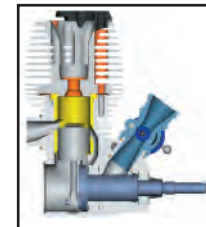

Bottom Dead Center

- ABC 20
 - Address 3
 - After-run procedure 41
 - Air density 33
 - Air filter 5, 6, 20, 23
 - cleaning* 23
 - foam* 20
 - housing* 19
 - oil* 5
 - Air/fuel mixture 24
 - Air/fuel ratio 24
 - Alignment settings 37
 - Altitude 29, 32
 - Antenna 13
 - crimp nut* 13
 - mount* 6
 - post* 13
 - sleeve* 13
 - tip* 13
 - transmitter* 9, 13
 - tube* 13
 - wrench* 13
 - Atmospheric conditions 24
 - Axle Carrier 6
 - Barometric pressure 33
 - Baseline setting 33
 - Batteries 5
 - 7.2V battery pack* 5
 - alkaline* 5
 - battery box* 6
 - charger* 5, 12, 26
 - NiCad* 10
 - NiMH* 10
 - receiver* 12
 - RX power pack* 5
 - BDC 20
 - Body Mount Post 6
 - Brake 6
 - brake pad* 39
 - setup & adjustment* 39
 - shoulder screw adjustment* 39
 - Bulkhead 6
 - Bumper 6
 - Bumper Mount 6
 - Camber 37
 - Carburetor 19, 20, 24
 - air intake* 19
 - fine-tuning* 33
 - fuel intake* 19
 - fuel mixture needles* 24, 31, 32
 - slide* 21
 - throttle arm* 19
 - Channel 10
 - Chassis 6
 - Clean-out 20
 - Clutch bell 19, 38
 - Crystal (X-tal) 10
 - Customer support 3
 - Cylinder sealing 28
 - Decals 8
 - Differential 6
 - Driveshaft 6
 - Driving 34
 - tips* 34
 - Dyno 20
 - e-mail 3
 - Engine (TRX 2.5R) 6
 - break-in* 20, 28
 - tank 1* 29
 - tank 2* 29
 - tank 3* 29
 - tank 4* 29
 - tank 5* 29
 - tank 6* 29
 - winter break-in* 30
 - clearing a flood* 43
 - combustion chamber* 20
 - connecting rod* 20, 40
 - crankcase* 19, 20
 - crankshaft* 19, 20
 - cylinder head* 19, 20
 - cooling fins* 20
 - fit* 20
 - head protector* 19
 - header* 21
 - mount* 19
 - piston* 21, 40
 - port* 21
 - shut-off clamp* 6, 19, 27
 - shutting off* 27
 - sleeve* 21, 40
 - starting* 28
 - terms* 20
 - tuning* 31
 - by temperature* 33
- EZ-Start™ 20, 26
 - battery* 27
 - controller* 19
 - drive unit* 19
 - motor* 6, 19
 - plug* 6, 19
 - glow plug wire* 19
 - ground wire* 19
 - negative wire* 19
 - positive wire* 19
 - protection mode* 27
 - using* 27
- Factory needle settings 25, 28
- Flag color 10
- Flame-out 20
- Flywheel 19
- Forward and reverse operation (shifting) 9, 34
- Frequency 10
 - clearing* 10
- Fuel (see also nitromethane) 5, 20, 22
 - dispensing bottle* 5
 - fuel line* 6, 19, 20
 - handling* 22
 - mixture* 20
 - other fuels* 22
 - pressure line* 6, 19
 - tank* 6, 19
 - filling with fuel* 23
 - fuel cap* 6
 - tank seal adjustment* 23

- Gear Ratio 38
- Glow plug 19, 20
 - driver* 20
 - fouled* 28
 - igniter* 26
- Hex Hub 6
- High-speed needle 19, 21
 - adjustment* 31
- Humidity 32
- Idle speed screw 19, 21
 - adjustment* 25, 32
- Jumping 34
- Lean 21, 25
- Low-speed needle 19, 21
 - adjustment* 32
- mAh 10
- Maintenance 40
 - after each hour* 40
 - after each session* 40
 - after-run maintenance* 41
 - periodic* 40
- Needle seat 24
- Needle valve 21
- Neutral position 10
- Nitromethane (nitro) 21
 - content* 21, 22
 - percentage* 20, 22
- O-ring 21
- On/Off switch 6, 9
- OptiDrive™ 6, 9, 15
- Pinch test 32
- Pivot Ball 6
- Priming 21
- Punch 21
- Quick Start 7
- Radio system (TQ-3) 9
 - adjustments* 14
 - servo reversing* 15
 - steering trim* 14
 - throttle neutral* 14
 - throttle trim* 14
- controls* 14
- installing batteries* 11
- power indicator* 9
- power switch* 9
- servo reversing switch* 9
- steering wheel* 9
- throttle neutral adjust* 9
- throttle trigger* 9
- trim* 10
 - steering trim* 9
 - throttle trim* 9
- Troubleshooting 42
- Tuned pipe 6, 19, 21
 - exhaust header* 6
 - exhaust tip* 19
 - pipe hanger* 6
- Turnbuckle (Toe Links) 6
- Two-speed (see also Transmission) 38
- Two-speed ratio 39
- Wear-in 21
- Weather conditions 33
- Wiring diagram 9
- WOT 21
- range* 9
 - range testing* 17
- rules* 16
- terminology* 10
- using* 17
- Receiver 9, 10
 - box* 6
- Rich 21, 25
- rpm 21
- Safety 4
- Servos 10
 - shifting* 6, 9
 - steering* 6, 9
 - throttle/brake* 6, 9
- Shift Rod 6
- Shock (Damper) 6
 - fine tuning* 35
 - mounting positions* 35, 36
 - tower* 6
- Skid Plate 6
- Slipper clutch 6, 40
 - adjusting* 37
- Spur gear 6
 - changing* 38
 - mesh* 38
- Stall 21
- Storage 40
- Suspension Arm 6
- Suspension tuning 35
 - caster adjustment* 35
 - pivot ball caps* 35
- TDC 21, 43
- Tire gluing 8
- Toe-in 37
- Tools and equipment 5
- Transmission 6
 - access plug* 6
 - adjusting* 38
 - tuning* 37
- Transmitter 9, 10
 - adjustment* 14
 - battery compartment* 9





T-MAXX 2.5R

OWNERS MANUAL

MODEL 4902

TRAXXAS[®]

1100 KLEIN ROAD, PLANO TEXAS 75074
1-888-TRAXXAS